



# CAVAN-TYRONE AND MEATH-CAVAN 400KV TRANSMISSION CIRCUITS

COMPARISON OF HIGH VOLTAGE  
TRANSMISSION OPTIONS:

ALTERNATING CURRENT  
OVERHEAD AND UNDERGROUND,  
AND DIRECT CURRENT  
UNDERGROUND

FINAL REPORT  
FEBRUARY 2009

Prepared for  
Northern Ireland Electricity and EirGrid



and associates



PB Power acknowledges, with grateful thanks, contributions from the following consultants associated with this work:

Landscape assessments:

Mark Turnbull, Landscape Architect, MTLA, Perthshire



Civil engineering:

Mark Magee, Associate of RPS, Letterkenny



Cable system design and costings:

Simon Lloyd, Cables Design Projects Director, CCI Cable Consulting international Ltd, Sevenoaks





## EXECUTIVE SUMMARY

### Introduction

1. NIE and EirGrid have proposed two new 400kV 1500MVA single circuit overhead transmission lines (OHL) and associated substations (the “Project”). The proposals include firstly an interconnector between their two transmission systems that would run from the vicinity of Turleenan in Co. Tyrone to the vicinity of Kingscourt in Co. Cavan, and secondly an EirGrid transmission reinforcement that would run from Kingscourt to the already established Woodland 400kV Substation in Co. Meath. Whilst Woodland 400kV Substation is already established, the substations near Turleenan and Kingscourt would be new.
2. As part of the required consultation and consents processes for such a development in both Northern Ireland and the Republic of Ireland, applicants need to consider carefully other possible technical solutions to establish whether any reasonable alternatives exist.
3. In 2008 the Applicants issued a brief entitled “Island of Ireland – Cavan – Tyrone and Meath – Cavan 400kV Projects – Preliminary Briefing Note – Overhead and Underground Energy Transmission Options”, and dated February 2008. This high-level brief outlined the proposed Project, raised some of the technical and environmental considerations, mentioned alternative technologies, and made some early predictions about costs. This present document reports on the detailed assessments that have been made since then, to add detail to that early outline and to update the cost estimates.
4. These assessments focussed upon two possible technical alternatives to the proposed new High Voltage Alternating Current (HVAC) overhead transmission line. These were:
  - HVAC underground cable (UGC), or
  - High Voltage Direct Current (HVDC) UGC.
5. This report seeks to establish the feasibility of these alternative underground technologies by making technical, environmental and cost comparisons between them and the proposed OHL Project. However, whilst the report includes a general discussion of system implications of installing long lengths of HVAC UGC it does not seek to establish the feasibility, from a system wide perspective, of installing such lengths of HVAC UGC on Ireland’s ‘all-island’ transmission network. Likewise, the report includes a general discussion of the system implications of embedding a HVDC circuit in an interconnected HVAC network, but again, it does not seek to establish the feasibility, from a system wide perspective, of installing such a HVDC circuit on this particular ‘all-island’ transmission network.
6. The comparisons of the technology alternatives have covered three main areas: technical feasibility, environmental impact, and cost differences. They have all been performed at a strategic level – this means the following:

- Technical – technologies have been assessed for feasibility and applicability, although no final design has been offered,
  - Environmental – landscapes have been assessed for their capacity to absorb high voltage underground cable connections, and a route search corridor has been identified, but no final route has been selected, and
  - Costs – estimates have been derived from supplier budget estimates, from previous known contract values, and price movement indices have been employed where appropriate, but firm costs from suppliers (which are costly to produce) have not been used. Therefore, whilst the greatest care has been taken in assembling these figures, an uncertainty range of some +/- 20% should be borne in mind when considering the results.
7. This report does not comprise a recommendation that any part of the route should be undergrounded. Equally it is not intended that a particular undergrounding route should be implied by this report. Rather, the report uses a set of environmentally based routeing principles to identify at least one corridor within which the use of UGC could be technically and environmentally feasible as an alternative to the proposed OHL.

### **Methods**

8. The team comprised the following:
- High voltage cable specialist
  - High voltage transmission specialist
  - Landscape architect
  - Civil engineering specialist with local knowledge
9. All members of the team surveyed the route in respect of their own specialist areas, normally working in small groups to facilitate understanding of the interactions in this complex project.
10. Unit costings were requested from cable and equipment suppliers. Where gaps in this information occurred estimates were derived from PB Power's own costing data.

### **Key findings**

11. The following key findings have emerged from the comparison of the proposed OHL Project with the undergrounding alternatives. They are based on the research carried out during this study, and they use the assumptions set out in the detail of this report.

### **Overhead Lines**

12. The transmission of electrical energy worldwide is primarily based on high voltage alternating current (HVAC) overhead line technology.

13. Over 98% of the onshore extra high voltage electricity transmission network in Europe (European Union, Norway and Switzerland) is of HVAC overhead line construction, with the balance being underground or undersea cable. Underground cable is mainly applied in urban or environmentally sensitive areas.
14. HVAC overhead line transmission is most common, primarily because it represents the lowest cost technically feasible approach to establishing and maintaining a secure electrical power grid. Global transmission development activity suggests that this preference by utilities for the use of overhead line is likely to persist into the future. OHL construction duration would be 2 to 3 years once land access negotiations were completed.

### **Underground Cables**

15. Regarding underground options, a number of countries have been actively considering the use of UGC in their transmission systems. To date, however, the rate at which transmission networks are being undergrounded is very low.
16. Since the longest XLPE transmission cable circuit installed to date runs for some 40 km, and most are less than 20 km long, a 140 km installation would comprise a "world first". Minimum construction duration would be 3 to 4 years.
17. That said, a continuous and technically feasible strategic UGC route search corridor that satisfies the routeing criteria has been identified here for this Project.

### **Construction Schedules**

18. Technically and organisationally, an OHL solution could be delivered quicker (2 to 3 years) than an UGC solution (3 to 4 years). Land owner access consent, which is likely to be an issue for either approach, is beyond the scope of this report.

### **System security**

19. System security all over Europe relies upon the relatively high availabilities provided by OHL networks. Whilst underground cables suffer less weather-related faults than overhead lines, extended cable repair times have caused their availability to be lower.
20. Even a double circuit UGC performance may not match that of a single circuit OHL over the long term. The introduction of significant quantities of UGC in strategic transmission routes may thus compromise system security to the extent that additional circuits may need to be built.

### **Energy losses**

21. Reactive compensation for underground cables and charging current would cause the losses of a 2-core per phase 1200mm<sup>2</sup> aluminium cable to be higher than for the proposed overhead line for average circuit transfers below about 900 MVA. For average circuit transfers above this, UGC losses would be lower than those of the OHL losses. Adoption of a somewhat more expensive 1600mm<sup>2</sup> aluminium UGC design would lower this cross-over point to around 840 MVA.

22. To satisfy the system planning 'N-1 criterion' the peak load on the proposed 400kV interconnector, under normal operating conditions, should not exceed 750MVA (50% of its capacity). Based on this an average power transfer of 500MVA is considered appropriate for calculating the expected operating losses. At this level of power transfer the operating losses for the OHL option would be significantly lower than those of the UGC option.

### **Environmental impact and EMFs**

23. Overhead line installations have the potential to impact visual amenity in certain environments, though this may be somewhat mitigated by careful routeing. Their effects on other aspects of the environment are more limited since, apart from the sites of tower foundations, they fly over most natural heritage (flora and fauna) and cultural heritage (archaeological) features.
24. Underground cable installations have the potential to impact natural heritage and cultural heritage, particularly archaeological features. This impact would be best mitigated through a combination of careful route selection and a comprehensive programme of land and facility reinstatement following the construction works, avoiding altogether designated areas if possible.
25. Electric fields from the proposed overhead line, and magnetic fields from both the proposed overhead line and the underground cable alternatives, would all be lower than European and Irish adopted ICNIRP Basic Restriction guideline limits.

### **HVDC**

26. HVDC transmission does not naturally integrate with HVAC systems, and does not impart to the network the natural resilience of HVAC connections. HVDC is inherently more complex than HVAC in all respects: design, construction, testing, maintenance, and operation.
27. An HVDC link would provide no advantage to the system operator in this particular application, and its terminal stations would require more planned outages than their HVAC equivalents. For these technical reasons HVDC is not recommended over the proposed overhead line connection.

### **Construction and lifetime costs**

28. It is estimated that the overall construction cost of HVAC overhead line for the whole Co. Meath – Co. Cavan – Co. Tyrone route (including interest during construction) would be €81M. In comparison, it is estimated that the overall construction cost of HVAC UGC for the whole route would be €588M. This represents an additional cost to complete the Project with UGC of €570, or more than seven times the OHL estimate.
29. It is estimated that the 40 year lifetime running costs of HVAC OHL over the whole Co. Meath – Co. Cavan – Co. Tyrone route would be €44M. In comparison, it is estimated that the lifetime running costs of HVAC UGC over the whole route would be €73M. This represents an additional lifetime running cost for the Project with UGC of



- €29M, or a little over one and a half times that for OHL (average transfer of 500MVA assumed).
30. Similarly, for HVDC with underground cable connections, it is estimated that the overall construction cost of HVDC links between Co. Meath and Co. Cavan, and between Co. Cavan and Co. Tyrone (including interest during construction), would be €672M. This represents an additional cost to complete the Project with HVDC of €591M, or more than eight times the OHL estimate.
  31. Again, it is estimated that the 40 year lifetime running costs of these HVDC links between Co. Meath and Co. Cavan and between Co. Cavan and Co. Tyrone would be €104M. This represents an additional lifetime running cost for the Project with HVDC of €60M, or more than twice that for OHL (average transfer of 500MVA assumed).
  32. Estimated present value end-of-life replacement costs for HVAC OHL, HVAC UGC and HVDC UGC are €5M, €34M and €39M respectively. The following whole route summary table presents these estimates with the construction and running cost estimates. The equivalent estimates for each section of the route are to be found in Section 8 and the Appendices of this report.

<b>Whole Route</b>					
<b>AC OHL and AC UGC</b>				<b>AC OHL and DC UGC</b>	
<b>Construction Costs + IDC</b>				<b>Construction Costs + IDC</b>	
	€M	£M		€M	£M
HVAC OHL	81	65	HVAC OHL	81	65
HVAC UGC	588	470	HVDC UGC	672	537
Difference	507	405	Difference	591	472
Difference (times)	7.3		Difference (times)	8.3	
<b>Lifetime Running Costs</b>				<b>Lifetime Running Costs</b>	
	€M	£M		€M	£M
HVAC OHL	44	35	HVAC OHL	44	35
HVAC UGC	73	58	HVDC UGC	104	83
Difference	29	23	Difference	60	48
Difference (times)	1.7		Difference (times)	2.4	
<b>40-year Replacement Cost</b>				<b>40-year Replacement Cost</b>	
	€M	£M		€M	£M
HVAC OHL	5	4	HVAC OHL	5	4
HVAC UGC	34	27	HVDC UGC	39	31
Difference	30	24	Difference	34	27
Difference (times)	7.3		Difference (times)	8.3	
<b>Overall Whole-of-Life Costs</b>				<b>Overall Whole-of-Life Costs</b>	
	€M	£M		€M	£M
HVAC OHL	129	103	HVAC OHL	129	103
HVAC UGC	695	556	HVDC UGC	814	651
Difference	565	452	Difference	685	548
Difference (times)	5.4		Difference (times)	6.3	

Note: totals subject to rounding error

## CONTENTS

	<b>Page No.</b>
1. INTRODUCTION / PROJECT OVERVIEW .....	1
1.1 Description of the Proposed Developments.....	2
1.1.1 Circuit I: Co. Cavan-Co. Tyrone.....	2
1.1.2 Circuit II: Co. Meath-Co. Cavan.....	2
1.2 Purpose of the present document.....	3
1.3 Structure of document.....	4
1.4 Assumptions on the alternatives compared .....	5
1.5 Conclusions .....	6
2. OVERVIEW OF HVAC TRANSMISSION AND OVERHEAD LINES .....	7
2.1 Introduction .....	7
2.2 400kV AC OHL technology .....	7
2.3 Aspects of OHL construction .....	10
2.4 OHL reliability.....	11
2.5 Conclusions .....	11
3. HVAC UNDERGROUND CABLES .....	12
3.1 Background.....	12
3.2 Cable technologies .....	12
3.3 Laying techniques.....	13
3.4 HVAC 400kV underground cable experience .....	14
3.4.1 General.....	14
3.4.2 Second Yorkshire Line.....	16
3.4.3 New Zealand.....	16
3.4.4 South West Connecticut .....	19
3.5 Underground Cable for the Project .....	20
3.5.1 Current Carrying Capacity (Rating) .....	20
3.5.2 Cable Swathe .....	21
3.5.3 Cable System Losses .....	27
3.5.4 Earthing and Bonding Design .....	29
3.5.5 Installation Design .....	29
3.5.6 Thermomechanical Design .....	30
3.6 Construction Schedule: UGC and OHL Conductor Availability.....	30
3.7 Environmental Considerations and the Approach to Cable Routeing.....	31
3.8 Conclusions .....	32

4.	SYSTEM CONSIDERATIONS FOR HVAC SOLUTIONS.....	34
4.1	Reliability and availability .....	34
4.1.1	General .....	34
4.1.2	Relevance of reliability and availability to electricity transmission .....	34
4.1.3	Reliability of OHL and UGC .....	35
4.1.4	Availability of OHL and UGC .....	36
4.1.5	Security of supply .....	38
4.2	Reactive power .....	39
4.3	Voltage fluctuations.....	42
4.4	Overvoltages.....	42
4.5	Electromagnetic fields (EMF).....	44
4.5.1	Effect of ground clearances on EMF strengths.....	44
4.5.2	ICNIRP EMF Exposure Guidelines.....	44
4.5.3	Guidelines Adopted .....	46
4.5.4	Electric fields.....	46
4.5.5	Magnetic fields.....	47
4.6	Electrical Losses .....	50
4.7	Operational issues .....	51
4.8	Flexibility .....	51
4.9	Conclusions .....	52
5.	OVERVIEW OF HVDC CONNECTIONS .....	54
5.1	HVDC experience .....	54
5.2	HVDC transmission technology .....	54
5.3	HVDC connection arrangements .....	56
5.3.1	Monopolar HVDC.....	56
5.3.2	Bipolar HVDC transmission .....	57
5.3.3	Modified bipole.....	58
5.3.4	Multi-Terminal HVDC Schemes .....	58
5.4	HVDC overhead lines .....	59
5.5	HVDC cables .....	59
6.	SYSTEM CONSIDERATIONS FOR HVDC SOLUTIONS .....	60
6.1	Availability and reliability .....	60
6.2	System strength .....	61
6.3	Reactive power .....	61
6.4	Harmonics and flicker .....	61
6.5	Overvoltages.....	61

6.6	Steady state and transient stability .....	61
6.7	System performance with multiple HVDC systems.....	62
6.8	Sub-synchronous torsional interactions between HVDC link and generators.....	62
6.9	Design Complexity .....	62
6.10	Operational issues for HVDC .....	62
6.10.1	Power reversal capability .....	62
6.10.2	Minimum HVDC power transfer .....	63
6.10.3	HVDC control arrangements.....	63
6.11	HVDC Losses.....	63
6.12	Future flexibility of HVDC .....	64
6.13	Environmental Issues.....	64
6.14	Project programme.....	64
6.15	Conclusions on HVDC Technology .....	65
7.	CABLE SEARCH CORRIDOR TERRAIN APPRAISAL.....	66
7.1	Introduction .....	66
7.2	Methodology .....	66
7.2.1	First Visit.....	66
7.2.2	Second Visit.....	67
7.2.3	Refinement of Landscape Type Assessment .....	68
7.3	Strategic Cable Routeing.....	68
7.3.1	Objective.....	68
7.3.2	Strategic Cable Routeing Criteria .....	69
7.3.3	Environmental Impact.....	70
7.3.4	Other General Observations.....	73
7.4	Landscape Patterns.....	75
7.4.1	Introduction .....	75
7.4.2	Landscape Pattern Descriptions.....	75
7.4.3	Examples of Routeing Constraints .....	78
7.5	The UGC Strategic Search Corridor .....	79
7.5.1	Woodland to Kingscourt.....	81
7.5.2	Kingscourt to The Border.....	83
	The Border to Turleenan.....	86
7.6	Conclusions on the Strategic UGC Search Corridor.....	89
8.	CONSTRUCTION AND LIFETIME RUNNING COST COMPARISONS.....	90
8.1	Discounted Cash Flow (DCF) .....	91
8.2	Estimates, Uncertainty, and Contingency .....	91
8.3	HVAC OHL costs .....	93

8.3.1	HVAC OHL capital costs.....	94
8.3.2	HVAC OHL operational costs .....	96
8.3.3	HVAC OHL replacement cost .....	97
8.4	HVAC Cable Costs .....	99
8.4.1	HVAC cable capital costs .....	100
8.4.2	HVAC UGC Operational costs.....	112
8.4.3	HVAC Underground Cable End-of-Life Replacement Cost .....	114
8.5	HVDC Costs.....	116
8.6	Summary of Costs .....	117
8.7	Sensitivity to Sterling / Euro Exchange Rate .....	126
8.8	Sensitivity of comparisons to HVDC cost assumptions .....	127
8.9	Conclusion for Costs.....	129
9.	CONCLUSIONS - COMPARISON OF TRANSMISSION OPTIONS .....	131
9.1	Technical summary.....	131
9.1.1	HVAC.....	131
9.1.2	HVDC.....	133
9.2	Environment.....	133
9.2.1	Terrain appraisal and Strategic UGC Route Search Corridor.....	133
9.2.2	EMFs .....	134
9.3	Construction and lifetime running costs .....	134
9.4	Overall Conclusions .....	136
Appendix 1 - Unit Cost Factors		
Appendix 2 - Summary Comparison Specific to Co. Meath – Co. Cavan (EirGrid) Section		
Appendix 3 - Summary Comparison Specific to Co. Cavan – Co. Tyrone (EirGrid) Section		
Appendix 4 - Summary Comparison Specific to Co. Cavan – Co. Tyrone (NIE) Section		
Appendix 5 - Summary Costs for the Overall Co. Meath - Co. Cavan – Co. Tyrone (NIE and EIRGRID) Route		
Appendix 6 - Extra High Voltage XLPE Underground Cable		
Appendix 7 - Scope of Civil Engineering Works for Cost Estimates		
Appendix 8 - Maps and Drawings		

## LIST OF FIGURES

Figure 1-1 – Schematic Representation of Proposed Developments .....	3
Figure 2-1 – Typical 400kV AC overhead line tower constructions .....	8
Figure 3-1 - Whakamaru-Otahuhu transmission corridor in New Zealand .....	18
Figure 3-2 - SWCT transmission project .....	19
Figure 3-3 - Cable Laying Arrangement Across Farm Land.....	23
Figure 3-4 - Directional Drilling Cable Arrangement.....	24
Figure 3-5 - Open Cut Road Crossing Arrangement.....	25
Figure 3-6 - Phase Spacing v Section Length (1200mm <sup>2</sup> cable carrying 1083A) .....	26
Figure 3-7 – Cable Circuit Losses .....	28
Figure 4-1 – OHL and UGC availability over 140 km .....	37
Figure 4-2 – Circuit Availabilities if Undergrounded (per unit).....	38
Figure 4-3 – Example intermediate substation topologies .....	42
Figure 4-4 – Calculated system resonant frequency - whole route underground.....	44
Figure 4-5- Variation of OHL electric field strength with distance from centre-line .....	47
Figure 4-6- Variation of OHL magnetic field strength with distance from centre-line .....	49
Figure 4-7- Variation of UGC magnetic field strength with distance (depth 1.05m) .....	49
Figure 4-8- Variation of UGC magnetic field strength with distance (depth 1.5m) .....	50
Figure 5-1- Example schematic diagram of an HVDC Link.....	55
Figure 5-2 - Simplified diagram of monopolar HVDC link with Earth return .....	56
Figure 5-3 - Monopolar link with metallic return .....	57
Figure 5-4 - Bipolar scheme with metallic return for the unbalance current .....	58
Figure 5-5 - Modified Bipolar Arrangement .....	58
Figure 7-1 - Comparison of working swathe of overhead line and UGC .....	71
Figure 7-2 - Two examples of Landscape Pattern 1 – Flat Agricultural Land .....	76
Figure 7-3 - Landscape Pattern 2 – Drumlin Valley .....	77
Figure 7-4 - Landscape Pattern 2a – Drumlin with Hill Slopes.....	77
Figure 7-5 - Landscape Pattern 2aa – Drumlin with Few Constraints.....	77
Figure 7-6 - Landscape Pattern 2b – Drumlin with Significant Constraints .....	77
Figure 7-7 - Landscape Pattern RC – Wide River Crossing.....	78
Figure 7-8 - Lakes .....	78
Figure 7-9 - Wet areas .....	78
Figure 7-10 - Areas of flooding and other features such as groups of houses and trees.....	78
Figure 7-11 - Steep slopes .....	79
Figure 7-12 - Drumlin top, trees, valley with trees.....	79
Figure 7-13 – Straight Line Starting Position.....	80
Figure 7-14 – Strategic UGC Corridor and Landscape Patterns – Co. Meath .....	82
Figure 7-15 - UGC Routeing Constraints, Landscape Character Types – Co. Cavan .....	84
Figure 7-16 – Strategic UGC Corridor and Landscape Patterns – Co. Cavan.....	85
Figure 7-17 - UGC Routeing Constraints, Landscape Character Types – Armagh .....	87
Figure 7-18 – Strategic UGC Corridor and Landscape Patterns – Armagh .....	88
Figure 8-1 – Comparison of Energy Losses for OHL and UGC .....	114
Figure 9-1 – Circuit Availability – Alternative Technologies (per unit) .....	132

## LIST OF TABLES

Table 1-1 - Options considered for 140 km 1500MVA connection with 3 substations .....	6
Table 2-1 – Extra high voltage circuit lengths in Europe .....	9
Table 2-2 – World activity on new 380-500kV OHL since 2000 .....	10
Table 3-1 - Summary of Significant Length 345 - 500kV XLPE UGC projects .....	17
Table 3-2 – Assumptions for losses calculations .....	28
Table 4-1 – Average unavailabilities for OHL and UGC .....	36
Table 4-2 – Circuit Availabilities if Undergrounded .....	37
Table 4-3 - Reactive compensation required for a 140 km 1500MVA connection .....	39
Table 4-4 - Reactive compensation assumptions for this study .....	40
Table 4-5 –OHL electric field strength calculations, 1 m above ground .....	47
Table 4-6 – Magnetic field – variation with electrical load .....	48
Table 4-7 – Magnetic field – variation with distance from centre-line .....	48
Table 6-1 – HVDC Converter Performance – Overall Unavailability .....	60
Table 7-1 – List of Landscape Patterns .....	75
Table 8-1 – Unit Costs of HVAC OHL (World) .....	95
Table 8-2 – OHL Lengths and Cost Estimates .....	96
Table 8-3 – OHL Maintenance Costs .....	96
Table 8-4 - Overhead Line Discounted Cash Flow Example .....	98
Table 8-5 - Cable Parameters: Assumptions .....	99
Table 8-6 – Civil Engineering – Preliminary Works Costs .....	101
Table 8-7 – Civil Engineering – Preliminary Works Costs by route section .....	101
Table 8-8 – Civil Engineering – Estimated Costs per km .....	102
Table 8-9 – Trenchless Crossings – Unit Cost .....	103
Table 8-10 – Special Civil Works Lump Sum Costs .....	103
Table 8-11 - Special Civil Works Lump-Sum Costs by Route Section .....	104
Table 8-12 – Summary of Civil Works Lump-Sum Costs, by Route Section .....	105
Table 8-13 – Intermediate Reactive Compensator Costs .....	107
Table 8-14 – Static Var Compensator Costs .....	108
Table 8-15 – Summary of Compensation Costs .....	108
Table 8-16 – Underground Cable Unit Costs .....	109
Table 8-17 – Terrain Types, Corridor Lengths, Length Allowances .....	110
Table 8-18 – Terrain Pattern Lengths by Corridor Section .....	111
Table 8-19 – Terrain Pattern, Drum Lengths and Unit Costs .....	112
Table 8-20 – UGC Installed Costs, by Corridor Section .....	112
Table 8-21 – UGC Maintenance Costs .....	113
Table 8-22 – Underground Cable Discounted Cash Flow Example .....	115
Table 8-23 – Comparative costs of HVDC solutions .....	116
Table 8-24 – Summary Costs Comparison – Whole Route (Euros) .....	119
Table 8-25 – Summary Costs Comparison – Whole Route (Sterling) .....	120
Table 8-26 – Summary Costs Ranking – Whole Route .....	121
Table 8-27 – Costs Overview – Co. Meath – Co. Cavan, EirGrid .....	122
Table 8-28 – Costs Overview – Co. Cavan – Co. Tyrone, EirGrid .....	123
Table 8-29 – Costs Overview – Co. Cavan – Co. Tyrone, NIE .....	124
Table 8-30 – Costs Overview – Whole Route .....	125
Table 8-31 – Costs Overview - Sterling / Euro exchange rate at 1:1 .....	127
Table 8-32 – Costs Overview - Sensitivity to HVDC cost estimates .....	128



## **Acronyms**

AAAC	all aluminium alloy conductor
AC, ac	alternating current
ACSR	aluminium conductor steel reinforced
AIP	All Island Project
CER	Commission for Electricity Regulation
CIGRÉ	The International Council on Large Electric Systems
DC, dc	direct current
DCF	discounted cash flow
EHV	extra high voltage
EMF	electromagnetic fields (particularly 50hz in this context)
ESBI	ESB International (ESBI), consulting subsidiary of the Irish Electricity Supply Board (ESB).
EURO	European Union
HVAC	high voltage alternating current
HVDC	high voltage direct current
Hz	hertz – cycles per second, a measure of frequency
ICNIRP	International Commission of Non-Ionising Radiation Protection
IDC	interest during construction
IRRC	intermediate reactive compensation compound
km	kilometre
kV	kilovolts, thousands of volts
kV/m	kilovolts per metre – electric field strength
kVdc	thousands of volts, direct current
LCC	line commutated converter
m	metres
MSC	mechanically switched capacitor
MVA	megavolt-amp – 1,000,000 volt-amps, a HVAC transmission equipment rating

MW	megawatt – 1,000 kilowatts, a measure of power
MWhr	megawatt hour – 1,000 kilowatt hours, a measure of energy
NI	Northern Ireland
pa	per annum
PIR	pre-insertion resistors
POW	point-on-wave (switching)
rms	root mean square - a type of average
RoI	Republic of Ireland
SVC	static Var compensator
SWCT	South Western Connecticut
TOV	temporary overvoltage
VSC	voltage source converter
WACC	weighted average cost of capital
WHO	World Health Organisation
XLPE	cross-linked polyethylene

## 1. INTRODUCTION / PROJECT OVERVIEW

33. NIE and EirGrid have proposed two new 400kV alternating current (AC) 1500MVA single circuit overhead transmission lines (OHL) and associated substations (the "Project"). The proposals include firstly an interconnector between their two transmission systems that would run from the vicinity of Turleenan in Co. Tyrone to the vicinity of Kingscourt in Co. Cavan, and secondly an EirGrid transmission reinforcement that would run from the vicinity of Kingscourt to the already established Woodland 400kV Substation in Co. Meath. Whilst Woodland 400kV Substation is already established, the substations near Turleenan and Kingscourt would be new.
34. As part of the required consultation and consents processes for such a development in both Northern Ireland and the Republic of Ireland, applicants need to consider carefully other possible technical solutions to establish whether any reasonable alternatives exist.
35. In 2008 the Applicants issued a brief entitled Island of Ireland – Cavan – Tyrone and Meath – Cavan 400kV Projects – Preliminary Briefing Note – Overhead and Underground Energy Transmission Options, February 2008. This high-level brief outlined the proposed Project, raised some of the technical and environmental considerations, mentioned alternative technologies, and made some early predictions about costs. This present document reports on the detailed assessments that have since been made to add detail that early outline and to update the cost estimates made there.
36. In the course of these assessments two possible technical alternatives to the proposal to build a new High Voltage Alternating Current (HVAC) overhead transmission line emerged. These would be:
- HVAC underground cable (UGC), or
  - High Voltage Direct Current (HVDC) UGC.
37. This report seeks to establish the feasibility of these underground alternatives by making technical, environmental and cost comparisons between the proposed OHL Project and these two alternative technologies.
38. The comparisons have covered three main areas: technical feasibility, environmental impact, and cost differences. They have all been performed at a strategic level – this means the following:
- Technical – technologies have been assessed for feasibility and applicability, although no final design has been offered,
  - Environmental – landscapes have been assessed for their capacity to absorb high voltage underground cable connections, and a route search corridor has been identified, but no final route has been selected, and

- Costs – estimates have been derived from supplier budget estimates, from previous known contract values, and price movement indices have been employed where appropriate, but firm costs from suppliers (which are costly to produce) have not been used. Therefore, whilst the greatest care has been taken in assembling these figures, an uncertainty range of some +/- 20% should be borne in mind when considering the results.

39. This report does not comprise a recommendation that any part of the route should be undergrounded. Equally it is not intended that a particular undergrounding route should be implied by this report. Rather, the work reported here applies a set of routeing principles to identify at least one corridor within which the use of UGC could be technically and environmentally feasible as an alternative to OHL.

## 1.1 Description of the Proposed Developments

40. The proposed new development, comprising two circuits together, would:

- improve the security of electricity transmission grid across the island of Ireland,
- improve the capacity for international energy trading, enhancing the downward pressure on energy costs both north and south of the border, and
- accommodate a greater quantity of renewable generation, particularly wind generation, on the island of Ireland.

41. The southern circuit between Co. Meath and Co. Cavan, in addition to supporting the above functions, would also reinforce power supplies to the growing electricity demand in the north east region of the Republic of Ireland.

42. The power system planners of EirGrid and NIE have chosen a single operating voltage for the Project, thus avoiding unnecessary transformation costs at the border.

43. The two parts of the Project are outlined below.

### 1.1.1 Circuit I: Co. Cavan-Co. Tyrone

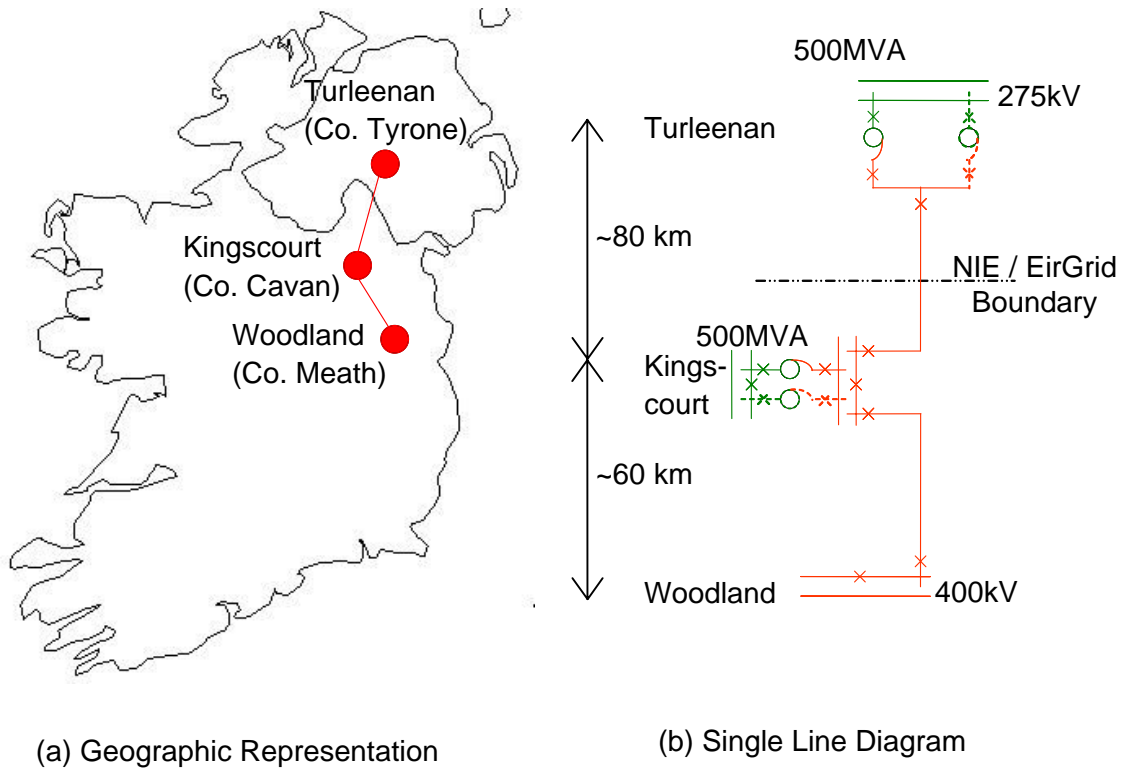
44. The existing electrical grid connections between Northern Ireland and the Republic of Ireland are to be reinforced by the addition of an interconnector between Co. Cavan and Co. Tyrone. This new 400kV, 1500MVA single circuit cross-border link would run about 80 km from a new 400/220kV substation in the vicinity of Kingscourt in Co. Cavan north to a new 400/275kV substation at Turleenan in Co. Armagh. It would supplement the existing double circuit 275kV connection near the eastern coast of the island of Ireland as well as the two existing 110kV single circuit interconnectors to the west. Figure 1-1 shows the proposal in geographic and single line diagram formats.

### 1.1.2 Circuit II: Co. Meath-Co. Cavan

45. It is proposed that the existing transmission network in the north-eastern part of Ireland be reinforced with a new 400kV 1500MVA single circuit connection running

some 60 km from the existing substation at Woodland north to the proposed new 400/220kV substation near Kingscourt. This is shown in geographic and single line diagram form in Figure 1-1.

**Figure 1-1 – Schematic Representation of Proposed Developments**



46. The existing 220kV Flagford-Louth circuit would be turned into the new substation near Kingscourt. At Turleenan the existing Tandragee-Tamnamore and Tandragee-Magherafelt 275kV OHL circuits would be turned into the new substation.

## 1.2 Purpose of the present document

47. This report considers the use of alternative technologies for the combined interconnector and transmission reinforcement development. It makes two sets of comparisons:
- high voltage UGC as an alternative to the currently proposed high voltage overhead line, and
  - high voltage direct current (HVDC) as an alternative to the currently proposed 400kV high voltage alternating current (HVAC) technology.
48. In each case it aims to identify issues of technical feasibility, indicate environmental considerations that may follow from each (an in-depth environmental impact assessment is beyond the scope of this document), and estimate costs that would be associated with the alternatives under consideration.

49. Many different combinations of the technology are theoretically possible, but most of these would not be efficient or practicable from an operational point of view. This document thus concentrates upon alternatives to the overhead lines proposed by NIE and EirGrid.
50. Regarding costs, the estimates included in this document are, wherever possible, based upon current supplier estimates and known costs for previous actual projects indexed to present day values.
51. That said, these estimates are necessarily subject to the changes in the prices prevailing in international markets. The world energy market has seen a run of high prices (compared to historic levels) recently, as well as significant rises in the prices of commodities, particularly metals. Worries about domestic price rises, reflecting the global situation, has led to a sustained increase in central bank lending rates whilst tightness in money markets has led to an increasing difference between central bank rates and commercial lending rates, causing a rise in project financing costs.
52. There is presently much debate about the levels of price rises due to speculative influences compared to the longer term underlying trends in prices being driven by higher levels of demand, especially from Asian countries. Thus, whilst the estimates in this document are “best present estimates”, there is an inherent uncertainty in them that is being driven by uncertainty of global price trends. For this reason the cost estimates should be treated with care; as future estimates and any final prices could be higher or lower depending on international trends.
53. Although the technologies employed are different, there are similarities in the raw materials used in each option presented here. For this reason, although the budget estimates contain uncertainty, we would expect this uncertainty to be lower when a comparison is made between the options. Therefore, we believe, that this document does offer a fair basis for comparison of technology alternatives, even given the global volatility in prices and price expectations.
54. Whilst this document does not consider the benefits of the proposed Project, but only the costs, it should also be noted that the full benefits of the proposal would be obtained only if the whole Project – both circuits – were to proceed together and if the technical issues were considered as a cohesive whole.

### **1.3 Structure of document**

55. The report is structured as follows:
  - Section 1 comprises this brief introduction to the Project,
  - Section 2 provides an overview of HVAC transmission connections (benefits and limitations),
  - Section 3 provides an overview of HVAC underground connections (benefits and limitations),

- Section 4 presents system considerations that require to be taken into account in the application of HVAC schemes, including benefits and compromises forced upon the system,
- Section 5 provides an overview of HVDC connections,
- Section 6 presents system considerations for HVDC
- Section 7 presents an appraisal of the terrain through which the connection would be made, including cost considerations,
- Section 8 provides cost comparisons, and
- Section 9 brings all the conclusions together.

56. Then:

- Appendix 1 contains some unit cost factors,
- Appendices 2 to 5 present cost estimate information specific to the various sections of the Project route, and for the route as a whole,
- Appendix 6 offers additional detail on the practical implications of choosing to install an extra high voltage (EHV) underground cable circuit,
- Appendix 7 contains details of the scope of the civil works that would be required to prepare the ground for the installation of EHV underground cable, and
- Appendix 8 contains the maps of the cable route search corridor discussed in Section 7 of the report. This Appendix also contains drawings of some of the extra equipment that would be required along the route if HVDC or underground cable were chosen.

57. A list of acronyms used within this report is provided on Page vii, immediately before the start of this main report.

#### **1.4 Assumptions on the alternatives compared**

58. Table 1.1 shows the comparisons that are made in this document.

**Table 1-1 - Options considered for 140 km 1500MVA connection with 3 substations**

AC/DC	Method of connection	Technology
HVAC: 3 substations connected at 400kV	400kV single circuit OHL	Steel lattice towers with ACSR <sup>1</sup> conductor set
	400kV single circuit, UGC, two cores per phase <sup>[2]</sup>	Cross linked polyethylene (XLPE) cables
HVDC: 2 links (4 converters) with intervening 400kV AC connection	OHL	Line commutated converter (LCC) <sup>a</sup>
		Voltage Source Converter (VSC) <sup>a</sup>
	UGC	LCC
		VSC

<sup>a</sup> There is further explanation about these alternative HVDC technologies in Section 5 of this report.

59. It is assumed that this 400kV, 1500MVA, single circuit HVAC overhead line scheme would be implemented using twin phase conductors, either all aluminium construction (AAAC) 700mm<sup>2</sup> ("Araucaria") or aluminium conductor steel reinforced (ACSR) 630mm<sup>2</sup>. ("Curlew").
60. Similarly, it is assumed that an HVAC UGC scheme would most likely be implemented using 400kV XLPE cable, either one or two cores per phase.

## 1.5 Conclusions

61. NIE and EirGrid have proposed a 400kV AC 1500MVA interconnector between Co. Tyrone and Co. Cavan, and an EirGrid transmission reinforcement of the same rating between Co. Cavan and Co. Meath.
62. Part of the formal Application and consents processes for both Northern Ireland and the Republic of Ireland requires that the Applicants consider carefully the alternatives to the proposed Project. In 2008 the Applicants issued a brief raising some of the technical, environmental and cost considerations for the Project, and this present document reports on the detailed assessments that have since been made on those subjects.
63. This report considers the potential for HVAC UGC and HVDC UGC as alternatives to the proposed OHL.

<sup>1</sup> ACSR = Aluminium conductor, steel reinforced, a commonly used overhead line conductor type. The three phase connections for the overhead line would each consist of a pair of ACSR conductors.

<sup>2</sup> Section 195 discusses the benefits of electrical separation of the UGC cores in order to obtain the operational benefits of two circuits.



## 2. OVERVIEW OF HVAC TRANSMISSION AND OVERHEAD LINES

### 2.1 Introduction

64. Originally electricity generation was with direct current, which could not easily be increased in voltage for long-distance transmission. Different classes of loads, for example, lighting, fixed motors, and traction (railway) systems, all required different voltages and so used different generators and different supply circuits.
65. This transmission of electric power at the same voltage as its generation and consumption placed a technical restriction on the distance between generating plant and consumers; long distance transmission either required conductor cross-sections that were unacceptably large and expensive, or the energy losses in the conductors were too great to deliver the required power.
66. However, this all changed with the advent of AC generation. Transformers provide an easy method of converting from one AC voltage to another, and this allows generators and consumers to operate at their preferred (lower) voltages whilst still providing energy transmission at the efficient (higher) voltages. As a result, remote and low-cost sources of energy, such as hydroelectric power or mine-mouth coal, could be exploited thus lowering energy production cost. Further, by allowing multiple generating plants to be interconnected over a wide area, electricity production cost was reduced as the most efficient available plants could be used to supply the varying loads during the day. Reliability was thus improved and capital investment costs were reduced, since stand-by generating capacity could be shared over many more customers and a wider geographic area.
67. The role of transmission networks today is to provide this efficient connecting network between multiple generators and diverse consumers.

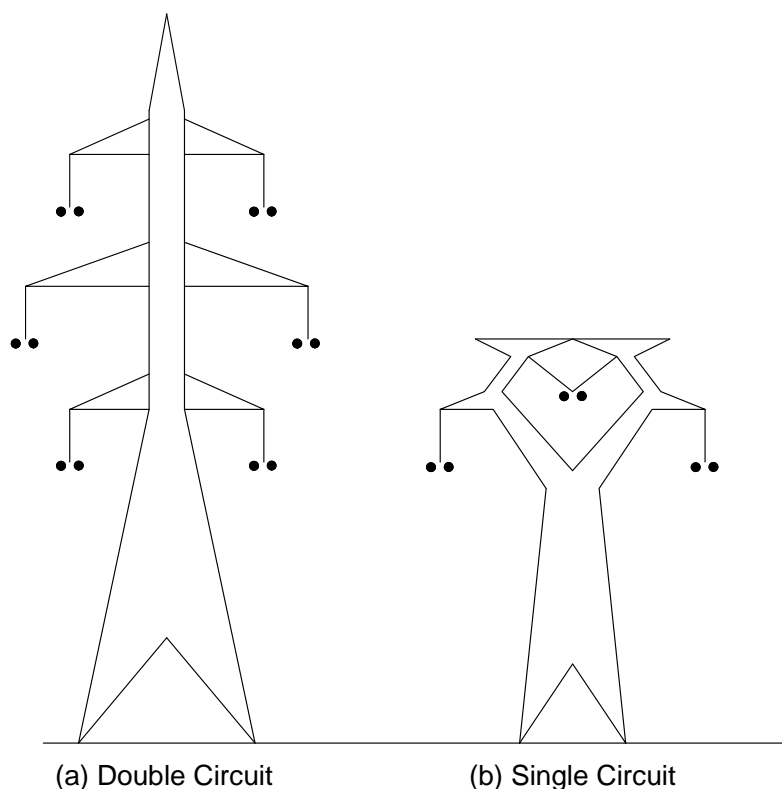
### 2.2 400kV AC OHL technology

68. A transmission system OHL comprises a conductor system suspended from towers or poles. The towers are made of wood (as-grown, or laminated), steel (either lattice structures or tubular poles), concrete, aluminium, and occasionally reinforced plastics. Insulators may be made from porcelain or glass, though increasingly polymeric insulators offering advantages of lower weight and higher strength may now be found. The bare wire conductors are generally made of aluminium (either aluminium alloy or aluminium reinforced with steel or sometimes composite materials).
69. Figure 2-1 shows two typical steel lattice structures. At 400kV a minimum of two (twin) “sub-conductors” per phase are used to control the level of corona discharge<sup>3</sup>. One HVAC transmission circuit requires three phases – see (b) – whilst two circuits require 6 phases – see (a).

---

<sup>3</sup> Corona is the phenomenon of tiny electric sparks discharging from the conductors into the atmosphere.

**Figure 2-1 – Typical 400kV AC overhead line tower constructions**



70. Figure 2-1 (a) depicts a double circuit tower type used in Ireland. This is typically 57m high, 9m square at ground level, and 19.5m wide at the tips of the widest arms. Though not shown in this drawing, an earth wire would normally be supported at the peak of the tower.
71. Figure 2-1 (b) depicts a single circuit tower of the type proposed for this Project. It is known colloquially as the IVI design to reflect the positions of the insulator strings supporting the three twin-conductor phases. Heights and base widths of this tower design vary depending upon terrain, but dimensions are, on average, 32m high, 7.6m square at ground level, and 19m wide between the tips of the arms. Though not shown in this drawing, earth wires would normally be supported by the highest parts of the tower, one each side of the centre-line at the tips of the “ears”.
72. The transmission of electrical energy worldwide is primarily based on high voltage alternating current (HVAC) overhead line technology. Over 98% of the onshore extra high voltage<sup>4</sup> electricity transmission network in Europe (European Union, Norway and Switzerland) is of HVAC overhead line construction, with the balance being underground cable. This latter is mainly applied in urban or environmentally sensitive areas. HVAC overhead line transmission is most common, primarily because it represents the lowest cost technically feasible approach to establishing and maintaining a secure electrical power grid. Table 2-1 shows the national figures.

<sup>4</sup> Transmission systems operating at or above 230kV are considered to be “extra high voltage” (EHV).

Table 2-1 – Extra high voltage circuit lengths in Europe

Country	Amounts in km <sup>[5]</sup>						Land Cable as Percent of Total Network (%)	
	380-400kV			220-300kV			380-400kV	220-300kV
	Land Cables	Sea Cables	Lines	Land Cables	Sea Cables	Lines		
Austria	56	0	2474	5	0	3765	2.2	0.1
Belgium	0	0	1325	0	0	400	0.0	0.0
Denmark	52	16	833	0	152	39	5.8	0.0
Finland	34	99	4000	0		2400	0.8	0.0
France	2	0	21007	903	0	25416	0.01	3.4
Germany	65	423	18200	45	0	26790	0.3	0.2
Greece	160	0	4156	232	0	11050	3.7	2.1
Republic of Ireland	0	0	438	106	0	1723	0.0	5.8
NIE	0	0	0	3	55	400	0.0	0.7
Italy	34	316	10651	197	0	10942	0.3	1.8
Luxembourg	0	0	0	6	0	236	0.0	2.5
Netherlands	7	0	2052	6	0	683	0.3	0.9
Norway	36	0	2144	0	64	5257	1.7	0.0
Portugal	0	0	1501	19	0	2854	0.0	0.7
Spain	80	15	18806	479	0	18757	0.4	2.5
Sweden	4	319	10620	0	87	4417	0.0	0.0
Switzerland	0	0	1780	20	0	4956	0.0	0.4
UK	166	327	11122	496	150	6321	1.4	7.1
<b>Total</b>	<b>696</b>	<b>1,515</b>	<b>111,109</b>	<b>2,514</b>	<b>453</b>	<b>126,006</b>	<b>0.6</b>	<b>1.9</b>

<sup>5</sup> These km lengths have been taken from "Statistics of AC Underground Cables in Power Networks", Cigré December 2007, UCTE Statistical Yearbook 2006, and "Undergrounding of Electricity Lines in Europe", Commission of the European Communities, December 2003. EirGrid and NIE have provided figures for their own table entries.

73. In May 2008, ESBI carried out a survey of CIGRE member countries to determine whether OHL continues to be constructed. A summary of the data from the 21 countries who replied to the survey questionnaire is given in Table 2-2.

**Table 2-2 – World activity on new 380-500kV OHL since 2000**

Activity since the year 2000 (route km)	Within the EC	Outside the EC
Constructed/commissioned	1990 km	5450 km
Currently in planning/consent process	2470 km	12,670 km
Currently under construction	450 km	2470 km

74. The extent of the 380-500kV HVAC OHL activity detailed in Table 2-2 can be compared with the cumulative length (207km) of significant 345-500kV HVAC XLPE UGC project examples (Table 3-1) that have been installed in the past decade. Although the data in these two tables are by no means a comprehensive picture of worldwide activity, they provide some indication of current expectations in Europe and elsewhere, of the balance being struck between overhead and underground transmission.

### 2.3 Aspects of OHL construction

75. The next chapter goes into detail about HVAC underground cables. For context and comparison, therefore, some information about HVAC OHL is provided here.
- Route survey and selection of tower positions would be performed in close cooperation with land owners and other locally affected parties, as appropriate. Routes of construction access tracks from roadway to tower positions would also be agreed at this time.
  - Towers, and thus concrete foundations, would be required on average about every 360m along the route. Foundations would be prepared, constructed, and allowed to cure with steel “stubs” protruding above ground level.
  - Steel corner legs and bracings would be pre-formed and drilled, before being transported to site. The towers would then be built in situ on the foundation stubs.
  - Insulator strings would be lifted into position on the tower, and pulleys attached to the bottom ends of the insulators.
  - Twin aluminium conductor, steel reinforced (ACSR), known as “Curlew”, is proposed for the phase conductors. Drums of these conductor wires would be delivered to one end of each straight section of the OHL route. The conductors would be drawn up and through each straight OHL section by a finer wire, with a winch at the other end of the section.
  - Once the conductors are in place, linesmen would traverse each span in trolleys supported by the conductors, to install phase conductor spacers. This completes the construction of the OHL.

## 2.4 OHL reliability

76. Overhead lines can experience both transient and persistent faults. Transient faults occur almost exclusively due to poor weather conditions – principally lightning strikes – but occasionally also due to galloping and clashing of conductors in high winds. Whenever such a fault occurs, circuit protection systems switch off the power supply to the affected item immediately, to avoid (or at the very least minimise) equipment damage. Automatic switching sequences are then triggered and, in the event that the fault proves to be transient, the OHL circuit is returned to service very quickly, and certainly within a few seconds.
77. Persistent OHL faults are rare. However, should such a fault be sustained, switching sequences would lock the line out of service, and repair teams would be sent to investigate and reinstate the line to serviceable condition. This process could take anywhere between two or three hours up to a couple of days depending upon the circumstances.

## 2.5 Conclusions

78. The transmission of electrical energy worldwide is primarily based on high voltage alternating current (HVAC) overhead line technology.
79. Over 98% of the onshore extra high voltage electricity transmission network in Europe (European Union, Norway and Switzerland) is of HVAC overhead line construction, with the balance being underground or undersea cable. Underground cable is mainly applied in urban or environmentally sensitive areas.
80. HVAC overhead line transmission is most common, primarily because it represents the lowest cost technically feasible approach to establishing and maintaining a secure electrical power grid. Global transmission development activity suggests that this preference by utilities for the use of overhead line is likely to persist into the future.

### 3. HVAC UNDERGROUND CABLES

#### 3.1 Background

81. Underground cables have been used to deliver electrical energy for many years. The first power distribution system developed by Thomas Edison used copper rods, wrapped in jute and placed in rigid pipes filled with a bituminous compound. Vulcanized rubber was applied to cable insulation in the 1880s, when it was used for lighting circuits. Rubber-insulated cable was used for 11kV circuits in 1897 installed for the Niagara Falls power project. Oil-impregnated paper-insulated high voltage cables were commercially practical by 1895. During World War II several varieties of synthetic rubber and polyethylene insulation were applied to cables.
82. The science of underground cables has developed steadily since those times. 380kV oil filled cable was first installed in the 1950s, and the UK 400kV supergrid, which included significant quantities of 400kV cable, was substantially completed during the 1960s. However, 400kV AC cable system designs relying on oil and paper insulation, whilst still prevalent on networks around the world, are becoming obsolete. The last European factory manufacturing such cables for land applications closed in 2008.
83. Underground cables play an important role in transmission applications, particularly in urban and congested areas, and areas where there are environmental concerns to be addressed. Recent examples in the British Isles where 400kV underground transmission cables have been used include the 20 km Elstree – St Johns Wood circuit installed in a tunnel in the London area, and the direct-buried undergrounding of about 5.7 km of the 75 km Second Yorkshire Line between Newby and Nunthorpe.
84. Underground cables for high capacity transmission remain significantly more expensive than the equivalent overhead lines, and their application continues to be focused on areas where overhead lines are particularly inappropriate or impossible to use.

#### 3.2 Cable technologies

85. UGC conductors need to be separated from earth by insulation (also known as dielectric)The following cable types (based on cable dielectric) are available for voltages up to 400kV:
  - **Low density polyethylene (LDPE):** A dry dielectric system, where the inner conductor is totally covered with extruded polyethylene.
  - **Cross-linked polyethylene (XLPE):** This dielectric is essentially the same as that in LDPE cable except that it has been chemically cross-linked in order to raise its maximum operating temperature from 70°C to 90°C.
  - **High pressure fluid-filled paper insulated pipe type cable (HPFF):** Three unsheathed, paper-insulated cores are pulled into a single steel pipe, which is then filled with an insulating fluid (previously termed oil).

- **Self-contained fluid-filled paper insulated cable (SCFF):** This type of cable utilises essentially the same type of paper and insulating fluid as an HPFF cable to form the cable dielectric. However, instead of being pulled into a steel pipe, a flexible extruded metallic sheath is applied to each individual core. The cable cores are thus self-contained and each can be laid separately directly into the ground.
  - **Self-contained fluid-filled paper-polypropylene laminate (SCFF-PPL) insulated cable:** This type of cable is a variation on the SCFF cable. The paper tapes used in the SCFF cable are replaced with PPL tapes. The PPL tapes have the same appearance and approximately the same dimensions as the paper tapes but actually consist of two layers of paper, with a layer of polypropylene in between. The benefit of this construction is that the capacitance and dielectric losses are significantly reduced.
86. The choice of cable technology is dependent on many factors, for example reliability, local manufacturing support, local custom and practice, and cost, and it is fair to say that different utilities around the world have different policies. The last five years has seen a very significant shift away from fluid-filled cable technology towards XLPE insulated cable (due to the environmental risks associated with leaking fluid), and the majority of extra high voltage (EHV) cable projects nowadays are implemented with XLPE.
87. XLPE insulated cables also offer the best ratings and the minimum charging current. However although the cable extrusion technology is relatively mature, the development of joints (splices) is considered to be less well established, with some resultant concern about impact upon reliability. That said, EHV XLPE cable circuits, containing multiple joints have been in operation since 1997 with generally reliable service. There has been more operational experience of 275kV than 400/500kV XLPE cable, and whilst some utilities have complete confidence in XLPE, others have exhibited caution largely due to the lack of experience with XLPE cable at these latter voltages.
88. Concerns are likely to fade as a good track record for long XLPE connections at these voltages becomes established, however, and XLPE insulation is now the HVAC insulation material of choice up to 400kV. Whilst recognising that other insulating materials exist, this report concentrates on the use and application of 400kV XLPE insulated cable systems for possible use on the NIE and EirGrid transmission systems.
89. It should, however, be noted that there is a limit to the world production capacity for HVAC XLPE cables – see further comment on this in Section 3.6.

### 3.3 Laying techniques

90. Historically, oil-filled type cable systems have probably been split approximately 50:50 between those that have been direct-buried and those that have been installed in tunnels. With oil-filled cable systems, the principal factors for using tunnels has been to facilitate forced cooling systems, for crossing rivers or to permit access into congested cities where road routes would be virtually impossible.

91. More recently, the trend with XLPE has been for the majority of new systems in an urban environment to be installed in tunnels, with relatively few direct-buried. The principal benefits of tunnels have included:
- Relatively easy access to permit the repair of the cable system (initial uncertainty about the reliability of 400kV XLPE made this a common reason in the past)
  - A tunnel facilitates high sensitivity measurement of partial discharge (PD) activity at joint positions much better than a direct buried system - again an issue associated with the limited service experience of 400kV XLPE.
  - The Japanese XLPE jointing system requires approximately 1 month to make off 1 joint bay which would be difficult to facilitate with open excavations above ground. The tunnel also permits greater control over the jointing environment e.g. cleanliness.
  - A tunnel permits the cable to flex once it is installed thus alleviating any significant thermo-mechanical forces acting on the joints.
92. A few direct buried XLPE cable systems have, however, been installed, and subsequent operating experiences has apparently been good. The most notable is the very first jointed 400kV XLPE cable system that was ever installed. This is the Copenhagen transmission network, installed in 1997. This comprised two circuits, one of 12 km length, the other 9 km.

### 3.4 HVAC 400kV underground cable experience

#### 3.4.1 General

93. The biggest users of 400kV transmission cable (as opposed to applications such as short power station connections and entries into substations) are:
- Denmark,
  - UK,
  - Singapore,
  - Japan, and
  - Hong Kong.
94. The majority of the 400kV cable installations for the countries listed above consist of fluid-filled type cable. That said, in the last 10 years the UK and Japan have commenced a transition to XLPE cable systems, although it should be noted that the **Japanese** HVAC XLPE cable has been installed to a very high specification not found anywhere else in the world, to minimise the risk of circuit failure. Their measures include ensuring particularly clean conditions when undertaking activities such as cable jointing during construction. This approach results in higher costs than might otherwise be expected. **Singapore** (approximately the size of the Isle of Wight, but



with as much 400kV cable as the UK) and **Hong Kong** have not yet moved towards XLPE at these voltages.

95. In response to public opinion, the **Danish** electricity and gas transmission company, Energinet, commissioned a technical review of their electricity network with a view to establishing policy on the use of overhead and underground connections.
96. On 2 April 2008, the review was presented to the Danish Minister for Climate and Environment. It outlines the environmental and landscape consequences of various expansion principles as well as the consequences for the security of supply, the functioning of the electricity market, and socioeconomics.
97. From the range of options considered for 400kV connections, Option C – that of putting new connections underground, and replacing towers on existing routes with modern equivalents with less visual impact was proposed as the way forward, since it addressed the question of reduced visual impact of the network in an affordable and technically achievable manner.
98. On 8 October 2008 the Danish Energy Authority Energistyrelsen issued new Administrative Guidelines which recognised the need for future expansion, and which required that thorough assessment of need and impact be performed as a pre-requisite for all transmission system reinforcements.
99. So far as their transmission network is concerned, these Danish Guidelines further recognised that Denmark is a world leader in the use of transmission cable, and required that this situation should be maintained. However, given that the use of long UGC is technically challenging and expensive, it directed that existing plans for three overhead lines should continue, whilst at the same time plans be put in place to reduce the landscape impact of shorter sections of existing circuits.
100. More recently, some **Middle East countries**, Saudi Arabia and United Arab Emirates (UAE), have installed a number of short lengths of 400kV XLPE cable, as detailed in the following Table 3-1.
101. The **USA** have traditionally used fluid-filled cable where its 345kV network is undergrounded. Ratings are limited with this design of cable however, and it is noted that the USA has now started to move towards XLPE cable, despite having no manufacturing capacity within the country.
102. Operationally, the **UK** probably has the longest experience with 400kV cable, with the England and Wales transmission system having been established in the 1960s. Experience has generally been good.
103. For the purposes of this report, XLPE rather than fluid-filled UGC has been assumed as the most appropriate technology for an underground solution because:
  - It minimises the requirements for reactive compensation,
  - Those manufacturers supplying cables are tending to favour producing XLPE cables rather than other cable technologies, and

- The XLPE cable cost is lower than other cable technologies.

104. HVAC UGC has not so far been used for long distance HVAC transmission. A selection of significant length 345 – 500kV XLPE UGC projects around the world is listed in Table 3-1. The list includes what is believed to be the longest XLPE cable circuit installed to date – it is housed in a purpose-built tunnel in Japan and runs for some 40 km. It may be seen from the table that, to date, most underground transmission circuits at these voltages are less than 20 km long. A 140 km installation would thus comprise a “world first” rather than a “known quantity” with proven operational track record.
105. A number of recent projects have used or have considered the use of UGC as an alternative to overhead line. Three examples associated with crossing rural environments in different jurisdictions are outlined next.

### **3.4.2 Second Yorkshire Line**

106. Teeside Power Limited (TPL) of the United Kingdom wished to connect a 1735 MVA power station that required National Grid Company (NGC) to reinforce its network to maintain compliance with its Licence obligations in relation to the network security standard. Given the programme of the TPL development, NGC permitted an initial connection of the power station subject to generation restrictions and the use of a generation intertrip scheme. However, in the longer term a 76 km 400kV Second Yorkshire Line was to be constructed with associated substation works. The interconnecting was to be by overhead line.
107. The Second Yorkshire Line was the subject of public inquiries in 1992 and 1995, that finally resulted in NGC undergrounding about 5.7 km of the of the route between Newby and Nunthorpe.
108. The Newby - Nunthorpe section that was undergrounded used 12 fluid filled cables laid in four trenches. The installation used a 40 m construction width for the cable trenches, a haul road, room for soil storage and a cable reserves. A 3 m strip of land on both sides of the arrangement was used to prevent damage to the cables from trees, hedges and buildings. The majority of the Newby - Nunthorpe route was laid in pasture land. Part of the route crossed a small plantation; however, to avoid felling of trees, directional drilling was used<sup>6</sup>.
109. The project was completed in 2004.

### **3.4.3 New Zealand**

110. The transmission infrastructure in the Whakamaru - Otahuhu transmission corridor in New Zealand transfers power generated in central and southern part of North Island combined with transfers from South Island north to the major load centre of Auckland which accounts for about one third of the country's demand.

---

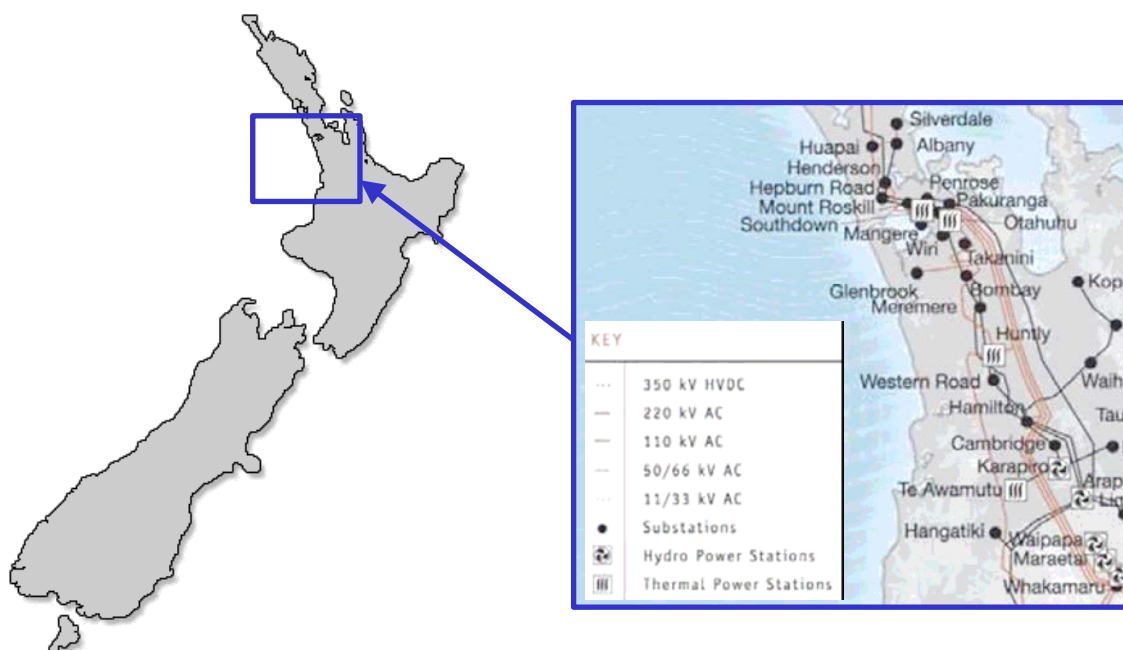
<sup>6</sup> The Highland Council, Cairngorms National Park Authority & Scottish Natural Heritage, Undergrounding of Extra High Voltage Transmission Lines.

**Table 3-1 - Summary of Significant Length 345 - 500kV XLPE UGC projects**

Utility	Date	Circuit Description	Manufacturer/ location	Route Length (km)	Conductor area (mm <sup>2</sup> ) & material	Type
NESA, Copenhagen	10/97	2x400kV 995MVA	NKT, Denmark	12 and 9	1600 Cu	Direct-buried.
NESA, Copenhagen	12/99	1x400kV 800MVA	NKT, Denmark	12	1600 Cu	Direct-buried.
Bewag, Berlin	07/00	2x400kV 1100MVA	1: Sudkabel 2: Nexans	5.4	1600 Cu	Tunnel + f/ vent *
TEPCO, Japan	11/00	2x500kV 900MVA	1: J-Power 2: Viscas	40	2500 Cu	Tunnel
ADWEA, UAE	12/00	4x400kV	Pirelli	1.25	800 Cu	Ducted
SCECO, Saudi Arabia	2001	2x400kV	Viscas	5.6	2500 Cu	Unknown
Taiwan Power Co.	04/02	8x345kV	Sudkabel, Mannheim	2.6	2500 Cu	Tunnel
KEPCO, Korea	06/03	1x345kV	LG, Gumi City, KOREA	11	2000 Cu	Unknown
REE, Spain	09/03	2x400kV 1700MVA	1: Sudkabel 2:Pirelli	13	2500 Cu 2500 Cu	Tunnel + f/vent *
Eltra, Denmark	2004	2x400kV 500MVA	Sagem, Montereau	14	1200 Al	D/buried + ducted
NESA, Copenhagen	12/04	3x400kV 1000MVA	NKT, Denmark	2.5, 4.5, 7.5	1200 Al	Direct-buried.
TenneT, Netherlands	2005	2 x 380kV 1000MVA	Prysmian	2.4	1600 Cu	D/buried + pipes
Weinstrom, Austria	2005	2 x 380kV 640MVA	Prysmian	5.2	1200 Cu	Buried, w/cooled
ENEL, Italy	2005	2 x 380kV 1600A	Prysmian	8.5	2000 Cu	Direct buried
NGET, UK	2005	2x400kV	Sudkabel, Mannheim	2.7	2500 Cu	Tunnel
NGET, UK	2005	1x400kV	Sudkabel, Mannheim	20	2500 Cu	Tunnel
ADWEA, Abu Dhabi	2006	1 x 400kV 1000MVA	Prysmian	8.5	2500 Cu	Direct buried
TEIAS, Turkey	2007	1 x 380kV 1500A	Prysmian	13.2	2000 Cu	Direct buried
NGET, UK	2008	2 x 400kV 1950MVA	Prysmian	6.3	2500 Cu	Tunnel + f/vent *

Note: f/ vent = forced ventilation

**Figure 3-1 - Whakamaru-Otahuhu transmission corridor in New Zealand**



111. With increasing demand in the Auckland and North Isthmus region of New Zealand, the electrical transmission company, Transpower, considered a number of alternative options to maintain compliance with its planning standard.
112. In view of community requests for more information on possible alternatives to an overhead transmission, Transpower and its consultants considered the potential for implementing the new connection by underground cable. They found that:
- The availability of a 400kV 200 km long cable circuit would be lower than for an overhead line,
  - Harmonic impedance resonance problems may be exacerbated by the higher capacitance of cables compared with overhead lines.
  - The use of cables requires skilled jointers and specialised equipment for initial installation and for later cable fault repairs,
  - More technically complex equipment would be required to operate and maintain a cable circuit when compared with an overhead line due to the need to provide intermediate stations along the cable route to connect shunt reactors for cable charging current compensation,
  - The environmental impact of excavating and replacing a large amount of soil to bury the cables would need to be considered for the cable system.
  - The project cost would be much greater than that for overhead line (8:1 ratio indicated by PB Power and 10:1 indicated by Transpower).
  - An alternating current cable system of this length and voltage has not been constructed previously anywhere in the world.

- Reasons for undergrounding included difficulty in obtaining transmission line routes through high density areas, entry to substations, crossing overhead lines, safety, and environment considerations.

113. Transpower also considered the effects of introducing short UGC sections on the reliability of a 400kV overhead line. The main issues of concern were:

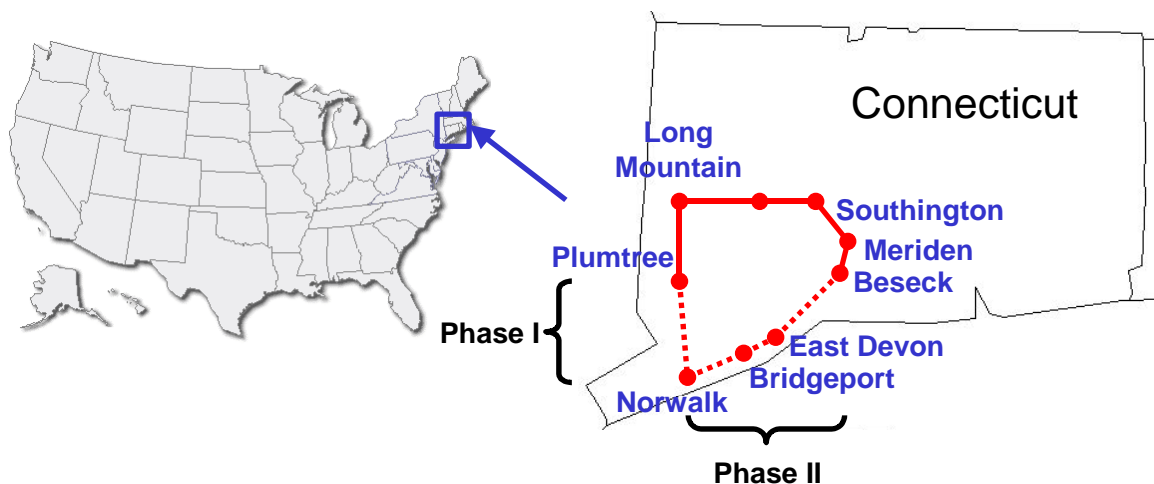
- Exposure of cable sections to overvoltages caused by lightning strikes on adjacent sections of overhead line; and
- Cable sections increase the number of components and potential failure modes on the transmission system.

114. At the time of this report The Electricity Commission (the New Zealand electricity supply regulatory body) has approved the construction of a new double circuit OHL with the capacity to operate at 400kV (initially 220kV) for the majority of the route. The final few km (to be decided once the substation location has been determined, but expected to be less than 5 km) will be cabled into the existing Auckland network.

#### 3.4.4 South West Connecticut

115. In 2001, the regional transmission expansion planning (RTEP) process identified the South Western Connecticut (SWCT) system as having severe reliability problems whenever the largest local generation source was not available and recommended feasibility studies to examine alternatives for major transmission upgrades to permit increased imports into the region. A project that closed the 345kV loop in SWCT was found to be the most attractive method of facilitating this<sup>7</sup>.

**Figure 3-2 - SWCT transmission project**



An important aspect of delivering the project was adherence to state law requiring the project to be undergrounded unless to do so would be technically infeasible. In fact only 24 miles (48 circuit miles) of the 57 mile route were undergrounded for this reason.

<sup>7</sup> Docket 272 Application Materials, The Applicants.

## 3.5 Underground Cable for the Project

### 3.5.1 Current Carrying Capacity (Rating)

116. The power transmission requirement for the Project is 1500MVA. At 400kV this requires a through phase current of 2165A. In addition to the through current however, the cable must also carry insulation charging current, the magnitude of which is proportional to the capacitance of the cable, and therefore its length. For short lengths of cable the magnitude of the charging current is not considered significant in cable rating calculations, however a 10km cable can lose in the order of 10% of its through rating due to this charging current.
117. The current carrying capacity of a cable is largely determined by the equivalent cross sectional area of the conductor and the electrical conductivity of the conductor material. Information<sup>8</sup> published on large conductor size cables indicates that a 400kV 3000mm<sup>2</sup> enamelled copper conductor cable has a rating of between 1545A and 1825A when buried directly in the ground. Some improvement in these ratings may be obtained by increasing the spacing between the phase conductors and by taking into account a lower ground temperature than used in the literature, however even with these allowances the rating falls short of the 2165A required for the circuit in question.

#### Water cooling

118. It would be possible to increase the current carrying capacity of large copper conductor cable by installing assisted cooling. For buried systems the most commonly used method of assisted cooling is with separately piped water. With this method, cold water circulated in pipes in close proximity to the power cables gathers a portion of the heat generated by the power cables, and transfers it to the atmosphere via heat exchangers – usually forced-air-cooled radiators installed at intervals along the route. The water cooling stations, requiring their own electricity and water supplies and telephone connection, would comprise buildings to house the heat exchangers, fans, water treatment plant and standby generation, and would be required every 3km or so along the cable route.
119. Water cooling is advantageous, for example, in areas where there is insufficient space to install naturally cooled cables, and the UK's National Grid has a number of such cooling systems. However, their reliability and availability is poor when compared to a naturally cooled system. Consequently, the reliability and availability of the Project circuits would not be increased by the use of a forced cooled system, and in fact such an arrangement would in all probability increase system losses, so this review assumes that any UGC associated with the Project would be designed to carry 1500MVA continuously with natural cooling.

---

<sup>8</sup> "60-500kV High Voltage Underground Power Cables, XLPE insulated cables", Nexans, Edition 12/2004

### **Two cores per phase**

120. Given the above considerations, if undergrounding were to be performed on this circuit then a two cables per phase would be required to meet the specified 2165A rating. Each cable would then carry half of the phase loading, that is, 1083A, which would enable cables with a smaller (and less expensive) aluminium conductor to be considered.
121. Prices have therefore been obtained for a 400kV cable system utilising a 1200mm<sup>2</sup> aluminium conductor cable along with the costs of accessories and installation. Prices have been obtained for both lead sheath and foil radial water blocking however only the lead sheathed cable prices have been analysed as this design is considered the most appropriate for the wet conditions on the island of Ireland – see also comments in Section 3.5.6.

### **Two circuits or one?**

122. A decision to underground the entire length of either or both of the proposed circuits with two cores per phase would offer the prospect of keeping the two cores electrically separate throughout their lengths, in which case, for a relatively small additional cost, the system benefits associated with two circuits could be realised. These benefits would not, however, be available if only partial undergrounding was undertaken, and costing estimates here assume the least-cost solution of one circuit with two cores per phase.
123. Using a round stranded 1200mm<sup>2</sup> aluminium conductor it is possible to achieve a rating of 1083A with appropriate burial depth and spacing arrangements. Options to use enamelled stranding, or Milliken (segmental) conductor design of the same cross-sectional area are also available to meet the rating at greater depths of burial, should this be required. Both of these options would, however, impact the cable pricing and would need to be weighed against other options, such as a larger diameter conductor and the use of copper, at the time of procurement.
124. At a depth of burial of 1050 mm, to achieve the required thermal energy transfer to prevent mutual overheating of the cables under continuous full load operation a minimum phase spacing of 750mm would be required. A 5 m group separation would also be required. Figure 3-3, Figure 3-4, and Figure 3-5 show three possible arrangements that would satisfy the thermal requirements under various conditions along the route. Actual arrangements would need to be confirmed at the time of procurement using the cable design offered by the supplier. however these drawings are likely to be typical for the cable conductor size considered.

### **3.5.2 Cable Swathe**

125. In general, it is preferable to minimise the number of joints on the cable system for reasons of reliability. However, the cable lengths to be installed may be affected not only by the weight and size of the cable drums but possibly also by the electrical limitation of induced sheath voltages – see further detail in Section 3.5.4.

126. Assuming, for the purposes of this strategic level study, the traditional sheath voltage limit of 150V, Figure 3-6 shows the relationship between cable phase spacing and acceptable bonding section length (drum length) for the 400kV cable with a 1200mm<sup>2</sup> aluminium conductor carrying a current loading of 1083A.
127. The maximum length of 1200mm<sup>2</sup> cable that can reasonably be transported on high grade roads is in the order of 1000m, this limit being due to the cable drum's physical dimensions and road height restrictions.
128. However, it can be seen from Figure 3-6 that when using a phase spacing of 750mm (as required by the current rating) the maximum length would be limited to around 730m when using a safety limit of 150V maximum on the cable sheath. Furthermore, for this particular project, it has been found on site by the specialist cable engineer that the nature of the terrain would very often dictate shorter lengths even than this, and for the purposes of the cost analysis in this report, section lengths in the region of 690m and 625m have been assumed when determining the quantity of joints, bonding and earthing equipment required. This allows some leeway for the selection of joint bay positions or shorter lengths under river crossings.
129. A drum of 400kV 1200mm<sup>2</sup> aluminium conductor XLPE insulated cable with a lead sheath and HDPE oversheath containing 690m of cable would have a gross weight of approximately 22 tonnes.
130. An operational swathe of similar in width to the construction working swathe would need to be kept clear of tree growth, buildings or significant earthworks for the life of the cable.



Figure 3-3 - Cable Laying Arrangement Across Farm Land

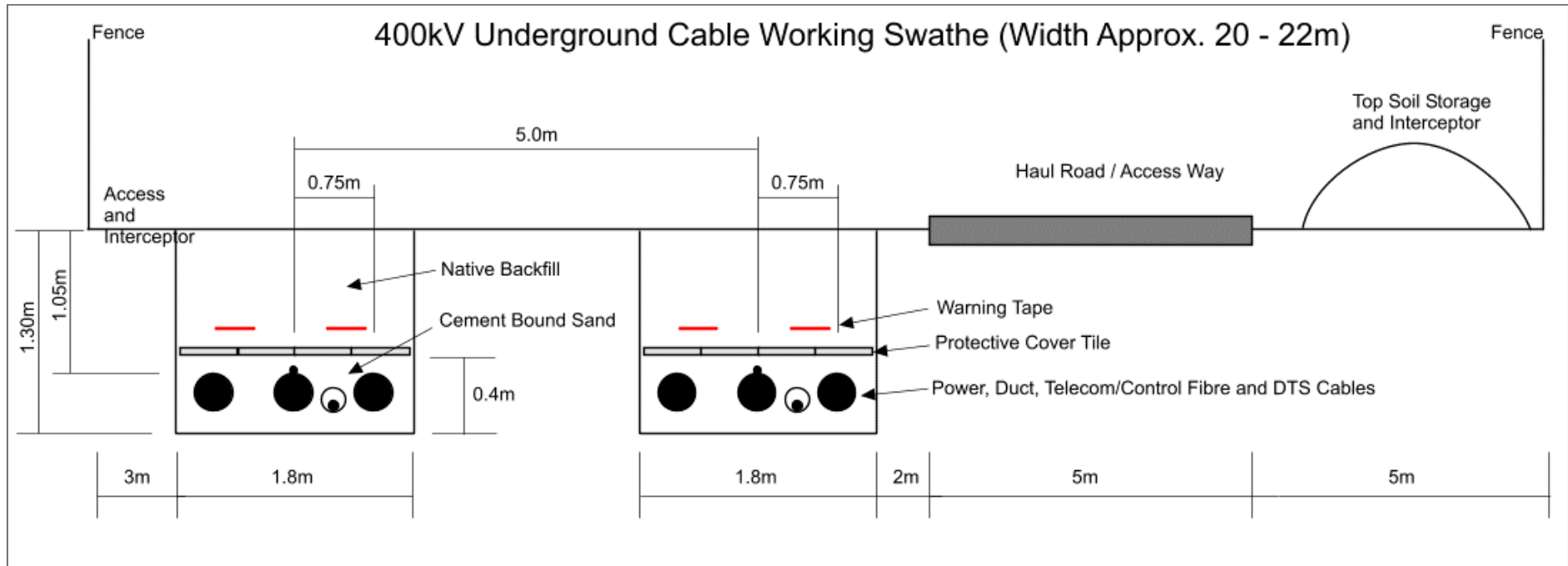


Figure 3-4 - Directional Drilling Cable Arrangement

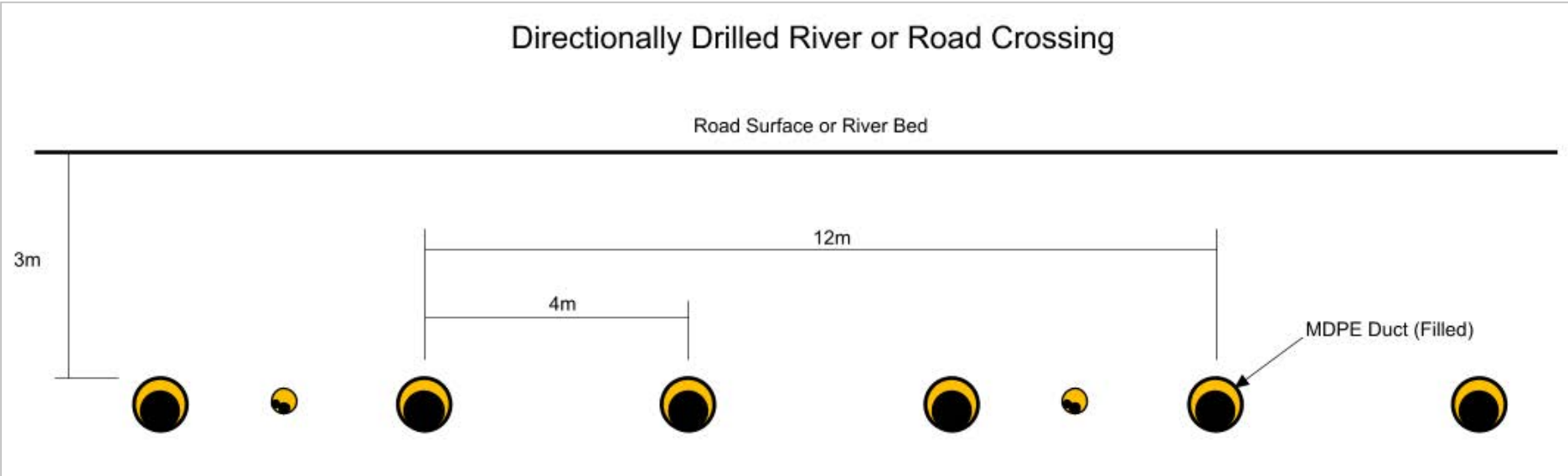


Figure 3-5 - Open Cut Road Crossing Arrangement

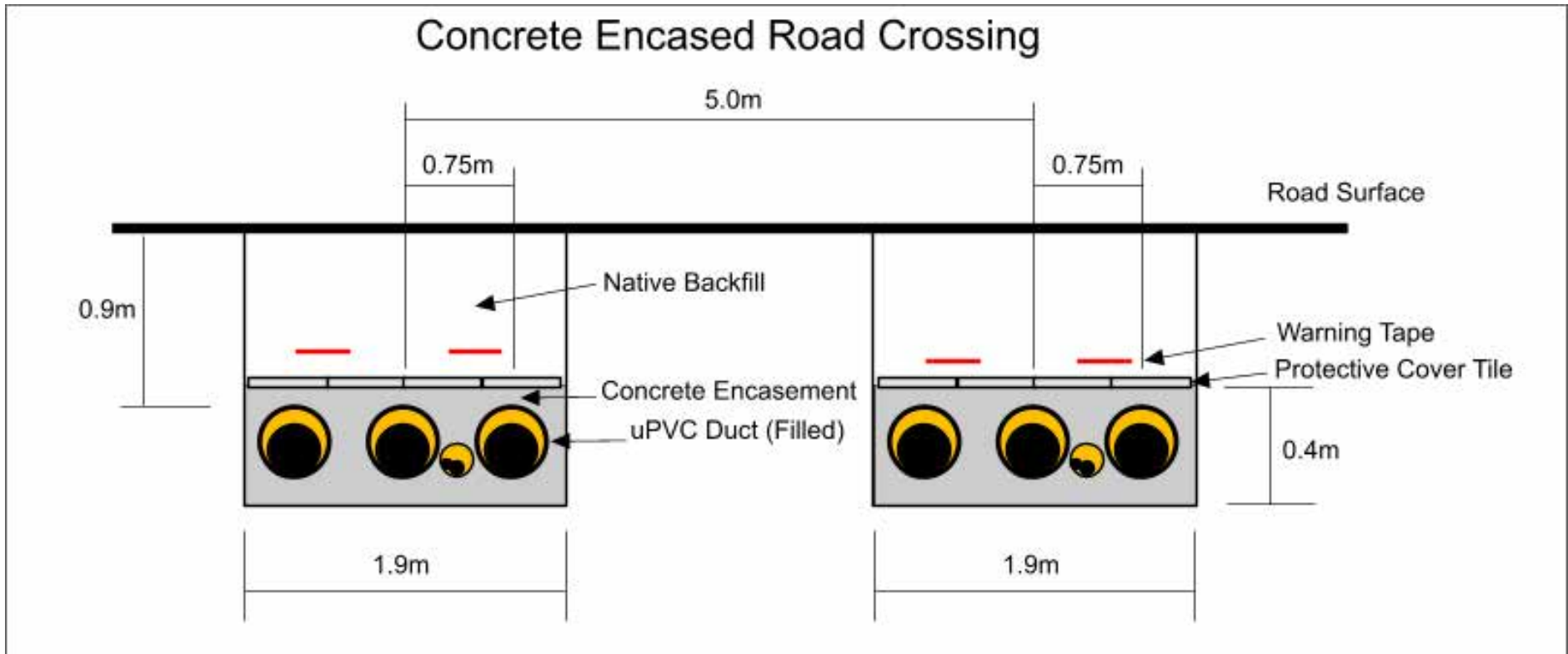
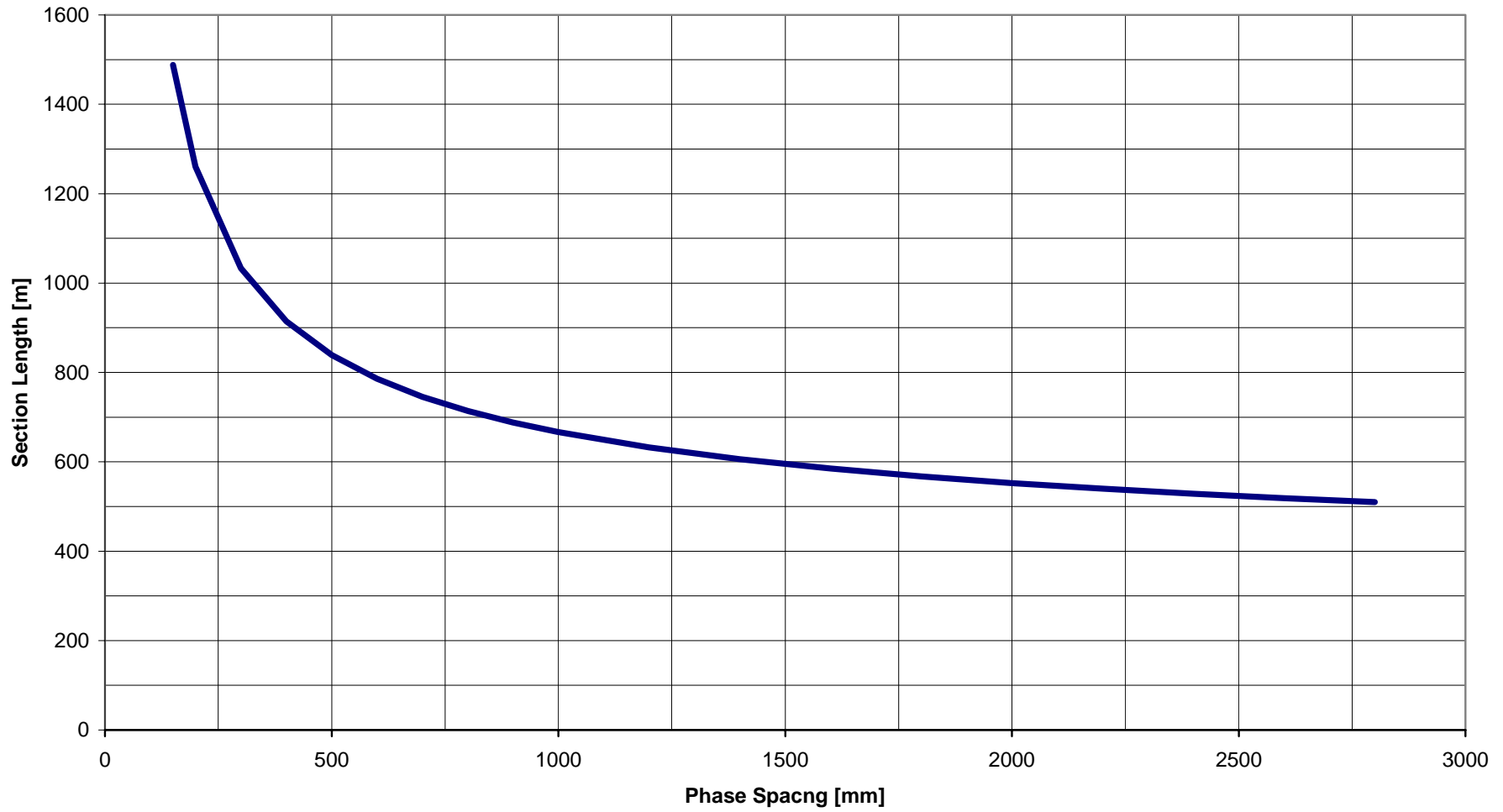


Figure 3-6 - Phase Spacing v Section Length (1200mm<sup>2</sup> cable carrying 1083A)

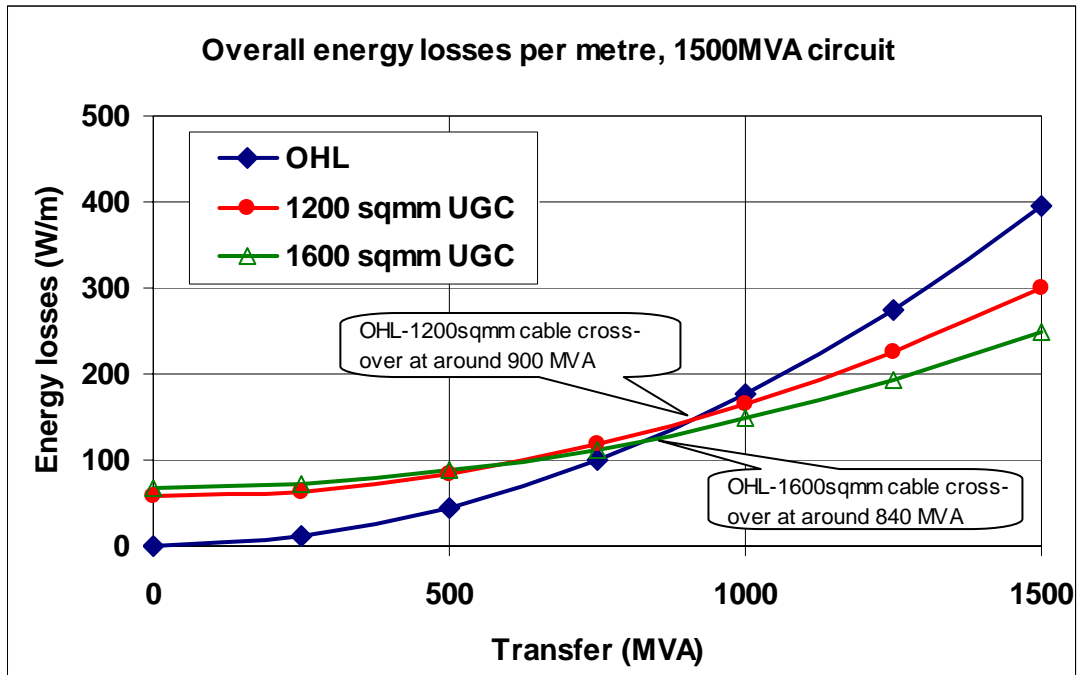
Section length to Phase Spacing Curve for an Induced Voltage Level of 150V



### 3.5.3 Cable System Losses

131. While initial capital cost of an installation is always very important, normally it is also worthwhile to consider running costs, and in particular the electrical energy losses during operation.
132. The although the proposed circuit would be rated at 1500 MVA, it would only ever need to operate at full load under emergency conditions. To satisfy the system planning 'N-1 criterion' the peak load on the proposed 400kV interconnector, under normal operating conditions, should not exceed 750MVA (50% of its capacity). Based on this an average power transfer of 500MVA is considered appropriate for calculating the expected operating losses.
133. Even at no-load, the cable and its compensation equipment would emit significant quantities of heat to the environment, whereas the proposed OHL would emit very little under the same circumstances. However, under high load conditions the UGC losses would increase relatively slowly compared to those of the OHL.
134. This phenomenon may be seen graphically in Figure 3-7, which compares, at various loadings, the overall energy losses for the proposed OHL with those for the 2 cores per phase 1200mm<sup>2</sup> aluminium cable. It may be seen from this graph that the OHL losses are lower than UGC losses for average transfers below about 900 MVA. Above this cross-over point, UGC losses would be lower than those of the OHL losses.
135. The same graph, Figure 3-7, also compares the energy losses of the OHL with an alternative 1600mm<sup>2</sup> aluminium cable in place of the 1200mm<sup>2</sup> construction. A similar cross-over point between this cable and the OHL may also be seen, this time at around 840MVA. For average transfers above this level an UGC would produce lower losses than an OHL. It is estimated that this larger core cable would add about 1.5% (or some €9M) to the capital cost of the Project, although this option has not been pursued in detail.
136. Since the expected average transfer of the Project circuit is around 500 MVA, it is anticipated that the overall operating losses on the circuit would be significantly lower for the proposed OHL option than for the UGC option.

Figure 3-7 – Cable Circuit Losses



137. Some of the main assumptions that were made in the calculations of this graph include:-

Table 3-2 – Assumptions for losses calculations

Power factor:	unity		
System voltage:	400kV		
	<u>OHL</u>	<u>1200 sqmm cable</u>	<u>1600 sqmm cable</u>
R (ohms / km):	0.0296	0.0247	0.0186
X (millihenries / km):	0.8	0.768	0.735
B (nanofarads / km):	14	0.18	0.2
Other parameter assumptions are to be found in Table 8-5			

138. Losses are also discussed in Sections 4.6 and 6.11 of this report. PB Power’s treatment of the OHL and UGC costs of these losses is described further in Sections 8.3.2.2 and 0 respectively.

### 3.5.4 Earthing and Bonding Design

139. In order to achieve the required cable circuit ratings the preferred method for earthing and bonding of the cable system are the special bonding arrangements described in Engineering Recommendation C55/4<sup>[9]</sup>.
140. The application of special bonding can reduce cable sheath heat generation considerably. However, a voltage will be induced into the cable sheath and screening wires. The magnitude of this sheath voltage increases with, a) the magnitude of the current flowing in each of the circuit phase conductors, b) the spacing between the cable sheath/screen and each conductor, c) the geometric arrangement of the cables within the cable trench (or trenches), d) the length of cable between specially bonded joints or terminations.
141. Traditionally it has been a requirement of Engineering Recommendation C55/4 that the voltage on cable sheaths under normal continuous operating conditions be limited to 150V for both 275kV and 400kV systems. This voltage limit is principally set for reasons of safety to third parties and to protect the cable joints whilst allowing reasonably long lengths of cable to be installed.
142. The sheath standing voltage and the drum weight are amongst the factors that can limit the maximum length of a cable section between joint and may thus affect the total number of cable joints on the circuit.

### 3.5.5 Installation Design

143. In addition to the section length criteria mentioned above, other factors that need to be taken into account when selecting section lengths include the following:
- Balanced minor sections (there are 3 minor sections to a major cross bonded section),
  - Sheath voltage limiter requirements,
  - Manufacturing weight and height restrictions,
  - HVAC testing capability and test set access positions,
  - Transportation limits e.g. vehicle width, axle weight and bridge heights,
  - Access through country villages and lanes,
  - Cable pulling-in force limitations,
  - Access to cable drum pulling-in and winch positions ,
  - Steep gradients, and
  - Permissible joint bay locations and maintenance access to link furniture.
144. The cable trench arrangement is an optimisation process taking into account the cost of cable and the cost of civil works for various trench widths and depths.

---

<sup>9</sup> "Insulated Sheath Power Cable Systems", Electricity Networks Association, Engineering Recommendation C55, Issue 4 1989 and Amendment 1 1995

145. Where special constructions are required for the cables to pass under or over obstructions, such as roads and rivers, these singular points require consideration within the overall design in order to establish that a route is both practical and economic.
146. Consideration of the cable installation arrangement must include the practicalities of the civil works and ensure that sufficient space and swathe is allowed to permit economic and safe working practices to prevail along the cable trench and at jointing locations.

### **3.5.6 Thermomechanical Design**

147. Conductors in cables of the type being considered can generate significant thermomechanical forces due to expansion and contraction in service.
148. Should cable routes be installed on steep profiles then some consideration would need to be given to the possibility of cable movement. There is some anecdotal evidence that 400kV cables installed on a steep gradient are subject to some sliding downwards.
149. Where gradients are significant, cable installers must perform a detailed thermomechanical design analysis. Cable snaking and the use of conductor anchor joints may be necessary in order to ensure that movement at the highly stressed cable/accessory interfaces does not occur. However, not all manufacturers produce anchor joints. Typically, cable snaking adds an additional 3% to the cable length requirement where this technique is employed.
150. The use of a seamless corrugated aluminium sheath (not as widely manufactured as a lead sheath) can improve thermomechanical performance due to its superior fatigue resistance. Some manufacturers however have experienced difficulties with water blocking and with ensuring insulation screen/sheath electrical continuity in large conductor cables with corrugated aluminium sheaths. Thus the use in Ireland of an aluminium corrugated sheath design would have to be explored carefully with the limited number of manufacturers before any commitment was made.

### **3.6 Construction Schedule: UGC and OHL Conductor Availability**

151. Most cable installations in the world today are less than 20 km long, and so a 140 km long 400kV cable circuit would be a major procurement order for any cable manufacturer. It is considered that 10 km a month of single UGC core is a realistic production rate from each of the world's EHV XLPE cable production lines.
152. If undergrounded, this Project would require at least  $6 \times 135 \text{ km} = 815 \text{ km}$  cable for two cores per phase, which implies 82 factory months (nearly 7 factory-years) to supply the high voltage cables. Suppliers may not be able to start on a production run for the Project immediately due to other orders. Even if two or three suppliers were involved manufacture would take at least 2 to 3 years, and it is quite possible that existing commitments to their other customers could push the delivery of the final drums of cable out 3 to 4 years from date of order.



153. Another factor affecting an UGC construction schedule would be the jointing. For the estimated 815 km cable core that would be installed, some 1250 joints would be required. Ten jointing teams working continuously for 10 months of the year would thus require a 3 year schedule once the first cables had been pulled into trenches on site.
154. For comparison, depending upon the number of installation teams simultaneously active on the Project, a 2 to 3 year programme would be reasonable to complete the proposed OHL installation.
155. That said, whether OHL or UGC is selected, land owner consent for access is likely to be a significant issue for the Project schedule. This aspect of the Project is beyond the scope of this report, however it should be recognised that technically an OHL could be delivered more quickly than an UGC.

### **3.7 Environmental Considerations and the Approach to Cable Routeing**

156. Major environmental impacts are likely to arise from the construction of cable trenches and associated construction works.
157. Land drainage in the area to either side of the construction swathe may need to be altered, either temporarily, or permanently with the agreement of the land owner. Hedgerows would need to be removed for the width of the construction swathe, and again, would be reinstated at the conclusion of the construction work.
158. UGC construction has a much greater potential effect on unknown archaeological sites since, rather than a disturbance once every 360m of the route by OHL foundations, the entire route length would be excavated, in patterns such as are indicated by Figure 3-3, Figure 3-4, and Figure 3-5.
159. Heat dissipation from the cables during operation may also cause unwanted visual effects on the vegetation above the cables – these effects would become visible particularly when viewed from above. This latter impact is likely to be least visible in flat arable land, more visible in improved or semi-improved grassland used for grazing and most visible in upland semi-natural or natural groundcover.
160. Due to the potential geographic scale of these impacts, the best way to mitigate and manage them is through route selection and successful habitat reinstatement through control of construction and heat emissions from cables in relation to soil type, groundcover and land use.
161. In addition, well routed cables would take into account other environmental and technical considerations and should seek to avoid altogether, where possible, habitats which are difficult to reinstate.
162. Further discussion on environmental impacts is provided in Section 7.3.3.

### 3.8 Conclusions

163. The last five years has seen a very significant shift away from fluid-filled cable technology towards XLPE insulated cable (due to the environmental risks associated with leaking fluid), and the majority of extra high voltage (EHV) cable projects nowadays are implemented with XLPE.
164. There is a limit to the world production capacity for HVAC XLPE cables. Given that the Project would require over 810 km of HVAC UGC core, if it was decided to underground the connections for the whole Co. Meath – Co. Cavan – Co. Tyrone route, XLPE cable manufacture could take 3 to 4 years even assuming supply from 2 or 3 reliable sources was available.
165. A number of countries have been actively considering the use of UGC in their transmission systems. To date, however, the rate at which transmission networks are being undergrounded is very low. The principal reasons for undergrounding appear to remain either a lack of physical space in urban environments, or the preservation of high levels of visual amenity in certain relatively short sections of transmission circuits.
166. Since the longest XLPE transmission cable circuit installed to date runs for some 40 km, and most are less than 20 km long, a 140 km installation would comprise a “world first”.
167. The power transmission requirement for the Project is 1500MVA. At 400kV this requires a through phase current of 2165A. Forced cooling would be an inappropriate way of obtaining this rating over the whole route of the Project, so two cables per phase would be required to meet the rating. Each cable would then carry half of the phase loading, which would enable cables with a less expensive aluminium conductor to be considered.
168. Two cores per phase would offer the prospect of keeping the two cores electrically separate throughout their lengths, in which case, for a relatively small additional cost, the system benefits associated with two circuits could be realised. However, costing estimates here assume the least-cost solution of one circuit with two cores per phase.
169. OHL operational losses would be lower than 2-core 1200mm<sup>2</sup> aluminium UGC losses for average circuit transfers below about 900 MVA. For average circuit transfers above this, UGC losses would be lower than those of the OHL losses. Adoption of a somewhat more expensive 1600mm<sup>2</sup> aluminium UGC design would lower this cross-over point to around 840 MVA.
170. Since the expected average transfer of the Project circuit is around 500 MVA, and since the nature of the Ireland network would tend to restrict planned circuit transfers to around 750 MVA, it is likely that the overall lifetime losses on the circuit would be lower if constructed with OHL rather than with UGC.
171. The cable construction working swathe would be some 20 – 22 m wide along the length of the route. An operational swathe of similar width would need to be kept clear of tree growth, buildings or significant earthworks.

172. Regarding construction schedule, technically and organisationally, an OHL solution could be delivered quicker (2 to 3 years) than an UGC solution (at least 3 to 4 years). Land owner access consent, which is likely to be an issue for either approach, is beyond the scope of this report.
173. Underground cables have the capacity to inflict considerable short-term (construction period) and long-term operational negative impact on the environment. This impact would be best mitigated through a combination of careful route selection and a comprehensive programme of land and facility reinstatement following the construction works, avoiding altogether designated areas if possible.

## 4. SYSTEM CONSIDERATIONS FOR HVAC SOLUTIONS

### 4.1 Reliability and availability

#### 4.1.1 General

174. **Reliability** of an item of equipment or a system may be considered to be its capacity to continue to operate throughout the period that it is called to do so. Reliability is often measured as the “mean time between failures” (MTBF), where the higher the MTBF, the more reliable is the item under consideration. The essence of reliability and its converse, unreliability, is the unexpected or unscheduled inability of the item under consideration to perform its intended function.
175. In contrast to this, **availability** of an item of equipment or a system is the total time under consideration (for example 8760 hours per year) minus the time required for maintenance (scheduled) and repair (unscheduled). Availability is thus highly dependent on the combination of failure rate and repair time.

#### 4.1.2 Relevance of reliability and availability to electricity transmission

176. All electrical power systems are susceptible to failure (un-reliability), however consumers place a high value on continuous supply (this is for many reasons, but a common reason for requiring uninterrupted supply is that most computer systems will “crash”, without warning, in the event of power failure. To reduce the risk of consumer power failure, some redundancy is built into the transmission system, making continuity of supply tolerant to single or sometimes double failures.
177. This system redundancy, coupled with the inherent thermal capacity of the system connectors, allows short periods (a few minutes) of unavailability to occur in the component parts of the transmission network without loss of supply to the consumer.
178. In the context of a transmission network with alternative paths to supply energy to the consumer, equipment availability becomes more crucial to quality of supply than does equipment reliability. In other words, equipment failure will be unlikely to impact availability of supply so long as the equipment can be quickly reinstated, repaired or replaced. Long-term outages on the other hand are likely to risk loss of supply to consumers, or the capacity of a generator to export energy, because of the increased likelihood that a co-incident fault occurs on the alternate supply path.

179. Factors affecting transmission circuit reliability include:

OHL	Cables
Mechanical reliability of conductors and joints	Cable insulation and joint integrity
Mechanical reliability of supporting insulators and towers	Integrity of covering ground (land shift, subsequent unintentional excavation or piercing)
Immunity to weather (the degree to which wind, ice, fog, pollution, and lightning affect reliability of an OHL depends upon the OHL design.	Immunity to lightning strike at termination

180. The availability of an UGC based solution relative to an overhead line based solution is influenced by:

- The reliability of the construction of the cable itself relative to that of an equivalent overhead line,
- The reliability of supplementary equipment required to be added to the system to permit an underground solution, for example terminations, joints, protection and health monitors and intermediate substations providing reactive compensation,
- The differing requirements for maintenance of UGC and overhead line and their associated supplementary equipment,
- The reliability of the overhead line's auto-reclose system to repeatedly reconnect following trips during foul weather conditions, and
- The fault repair times of an underground cable compared to those of an overhead line, taking into account the time to locate as well as to repair the fault.

#### 4.1.3 Reliability of OHL and UGC

181. Robust reliability statistics are difficult to obtain because, not only are primary power system assets normally well maintained and fail rarely, but also there is often a degree of coyness (on the part of both equipment suppliers and owners) regarding failures. In addition, though most primary transmission equipment is reckoned to operate in a cost-effective manner for 40 to 60 years, some currently used technologies have not yet accumulated a 40 year track record, so their performance, when aged, is not yet certain. This is particularly the case for XLPE transmission cable which, having been introduced at these voltages in the 1990s, is still a comparatively new technology.

182. It is certainly the case, however, that OHL, a mature technology, is susceptible to environmental effects such as being struck by lightning, and thus normally exhibits fault rates higher than those of cable circuits. Conversely, UGC circuits are very well shielded from these environmental impacts and only their ends, if insulated by air,

have the prospect of, for example, being struck by lightning. An underground cable circuit is thus normally more reliable than its equivalent overhead line.

#### 4.1.4 Availability of OHL and UGC

183. This position is usually reversed when it comes to availability. Whilst OHL generally suffers more interruptions than their equivalent underground cables, the vast majority of these interruptions are transient in nature and the lines are normally returned to service automatically within seconds of the interruption occurring. Consequently other paths within the transmission system can accommodate the briefly diverted load and the OHL interruption normally has no impact on consumers at all.
184. UGC circuits, however, do not suffer transient faults. If a fault does occur in a cable or in one of its joints, be it a design failure or an accidental intrusion by a third party, the consequence is almost invariably destructive and thus persistent. As a result, all UGC faults are treated as persistent and are investigated before the circuit is returned to service.
185. These circumstances mean that average repair times for cables are much higher than those for OHL, being measured in weeks rather than hours.
186. There are two factors that compound this difference. Firstly, it is normally much easier to locate an OHL fault than an UGC fault. Secondly, the technology and skill-set required to effect an OHL repair would generally be much more readily available locally than would be the extremely specialist requirements of an UGC repair at transmission voltages. In fact, appropriate people and equipment for such EHV UGC repairs do not reside in Ireland. These two factors, when taken together with the destructive nature of cable faults, yield significantly lower expected availabilities for UGC circuits, length for length, than for circuits comprised entirely of OHL.
187. The average unavailability times indicated in Table 4-1 are based on data published by the European Commission (EC), and these take into account both the reliability (the probability of an unplanned disconnection) and the outage durations (the time taken to restore the circuit to service):

**Table 4-1 – Average unavailabilities for OHL and UGC<sup>10</sup>**

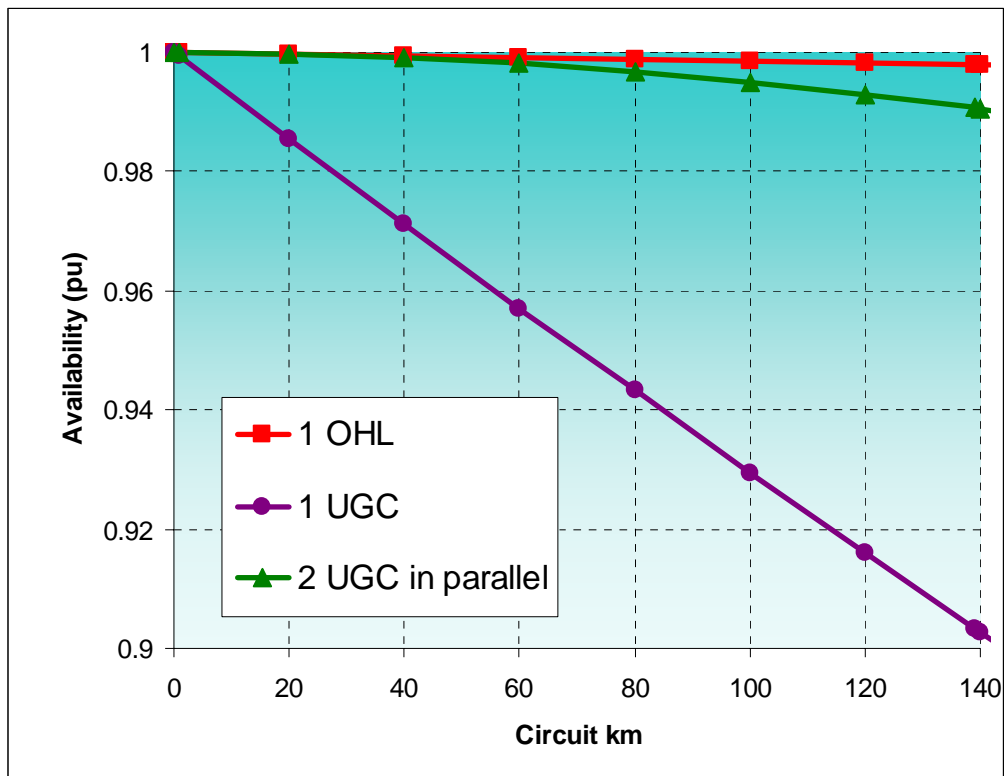
	Hours per circuit km pa
<b>OHL</b>	0.126
<b>UGC</b>	6.4

188. The difference between these two performances become very significant for long circuits. Figure 4-1 Shows how the availability of a 140 km OHL is around 99.8% pa compared to the UGC 90.3%.

<sup>10</sup> Overview of the Potential for Undergrounding the Electricity Networks in Europe, ICF Consulting, Prepared for the DG TREN / European Commission, February 2003.

189. If two such UGC circuits were put in parallel (as could be chosen if the UGC installation comprised 2 cores per phase) their combined availability would rise towards that of the OHL, achieving 99.1% between them, although, assuming that this double circuit was effected by electrically separating the two cable cores of each phase, only a 50% capacity would be available during any one cable circuit repair period.

**Figure 4-1 – OHL and UGC availability over 140 km**

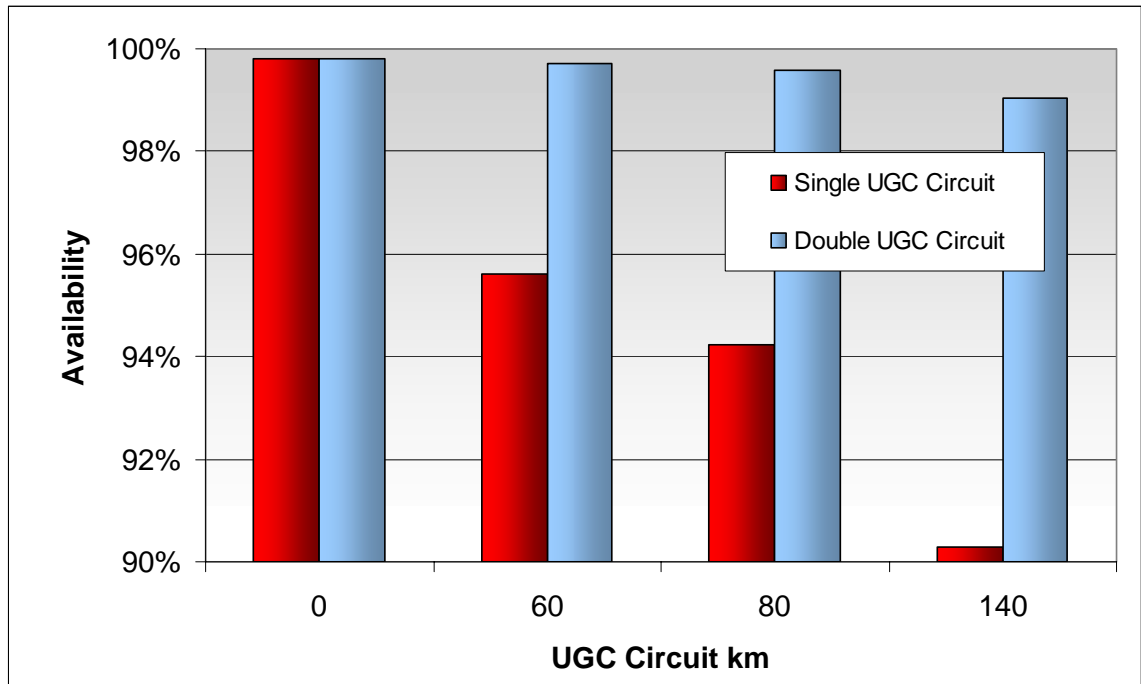


190. If these OHL and UGC unavailabilities are applied to circuit lengths of 60, 80 or 140 km, as would be the case if one or both parts of the Project were to be undergrounded, then estimates of the circuit and overall connection availabilities may be calculated. The results of such calculations are shown in the following Table 4-2 and in Figure 4-2.

**Table 4-2 – Circuit Availabilities if Undergrounded**

Length of OHL (km)		140	80	60	0
Length of UGC (km)		0	60	80	140
Overall 140km circuit availability	Single circuit UGC	99.8%	95.6%	94.2%	90.3%
	Double Circuit UGC	99.8%	99.7%	99.6%	99.1%

**Figure 4-2 – Circuit Availabilities if Undergrounded (per unit)**



191. It may be clearly seen from the table that the more cable that is substituted for OHL, the lower would be the availability of the circuit. However, if the phase cores of the cable were separated to provide two cable circuits, then the availability of the combined double circuit improves. Even so, it does not match the OHL performance, having an expected unavailability of 0.9%, that is, 4.5 times worse than the 0.2% unavailability of the single circuit OHL.
192. It should be noted that, depending upon the final system design, failure of any of the reactive compensation components could have an additional negative impact upon the unavailability of the UGC. Ignoring this aspect, however, for this particular application, UGC availabilities would need to improve by more than twice for the double circuit UGC to match the OHL performance, and by more than 50 times for the single circuit UGC to match OHL.

**4.1.5 Security of supply**

193. Since transmission system redundancy normally allows transmission networks to accommodate brief outages without affecting their customers, it may be seen that, if return-to-services times are short, equipment reliability in itself is not a major issue. Rather, it is equipment availability that impacts most heavily on transmission network system security.
194. In Northern Ireland and the Republic of Ireland, the power system is designed to defined security of supply standards<sup>11, 12, 13</sup>. These require that a certain amount of

<sup>11</sup> Transmission Planning Criteria, ESB National Grid, October 1998.

<sup>12</sup> Security of Supply, Engineering Recommendation P2/5, Electricity Networks Association, October 1978 and NIE amendment sheet, Issue 2.



redundancy is built into the transmission system to accommodate forced and planned outages while maintaining supplies to customers. Thus, they take advantage of the high equipment availability that OHL can offer.

195. This approach is not restricted to Ireland, however. The levels of UGC relative to OHL in European transmission systems are shown in Table 2-1. In the event that UGC circuits are introduced into any main interconnected transmission system it may become necessary to duplicate the circuits in order to retain the required security levels.

## 4.2 Reactive power

196. The capacitance added to the system by adopting a 140 km UGC based connection would be considerably higher than when implementing a 140 km overhead line based solution. UGC thus requires increased levels of compensation. This would certainly need to be installed at the terminating substations and possibly at one or more intermediate substations along the route.
197. Typically, overhead line systems are compensated by between 60% and 80%<sup>14</sup>. The level of reactive load produced by OHL and UGC solutions for the combined 140 km connection are compared in Table 4-3.

**Table 4-3 - Reactive compensation required for a 140 km 1500MVA connection**

Technology	Level of circuit reactive load (MVar)
HVAC 400kV Overhead Line	100
HVAC 400kV Underground Cable	2550 <sup>[a]</sup>

<sup>[a]</sup> to achieve transfer 2 x 1200mm<sup>2</sup> conductors per phase assumed

198. The number of intermediate compensation substations, and the associated requirements for reactive compensation would be dictated by the requirement to control the level of charging current flowing in the cable circuits as well as the voltage regulation required by the system designers. The fewer the number of intermediate substations provided on any UGC installation, the greater the voltage regulation and cable charging current. As charging current rises, less of the UGC transmission capacity is available for transmitting energy to the customer. To some extent, smaller, more regularly sited compensation units should be easier to deliver to site, too.

<sup>13</sup> Planning Standards of Security for the Connection of generating Stations to the System, PLM-SP-1, September 1975, and NIE amendment sheet, Issue 2.

<sup>14</sup> Compensation is usually restricted to about this level, particularly in double circuit overhead line arrangements, to avoid tuning the natural frequency of the overhead line connection to 50 Hz and causing resonance on a de-energised circuit through mutual coupling with an energised circuit on the same tower. It should however be noted that, particularly in the case of the underground cable application, it would be necessary to confirm that the system can supply the required level charging current in partially compensated scenarios.

199. In practice, the decision on how many intermediate substations to use and what size of UGC conductor to employ, in the context of a number of other inter-related factors, would be a complex design balance that would face both the NIE and The EirGrid system designers. For the purposes of this study however, and given various approximations for the sake of simplicity, assumptions have been made as shown in Table 4-4.

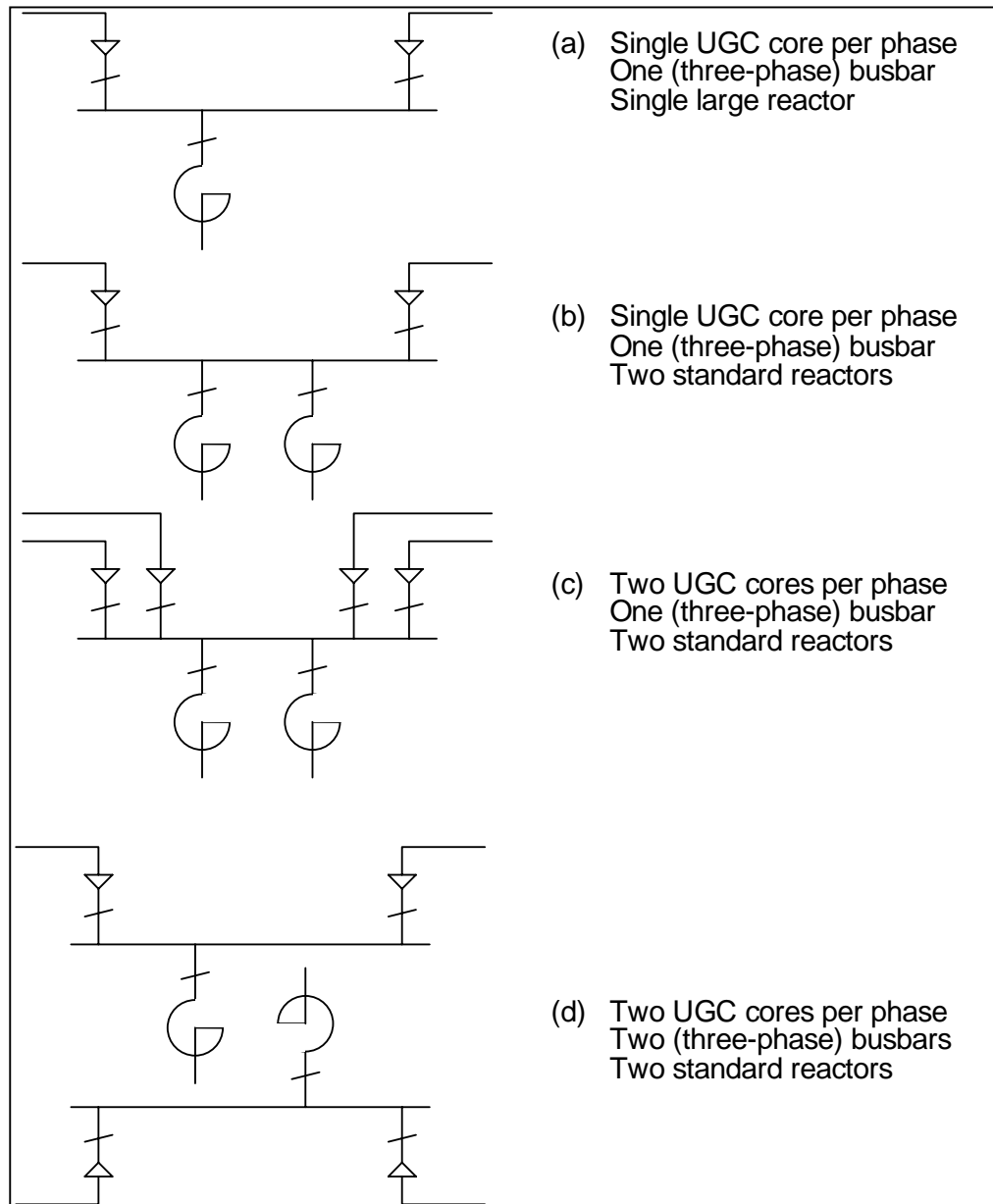
**Table 4-4 - Reactive compensation assumptions for this study**

Item	Assumption
Voltage regulation over the length of the overall Project route	limited to less than 4%.
Compensation at terminating substations	An SVC provided at each of the three substations.
Number of intermediate reactive compensation substations:	2 shunt reactors on the 80km route between Turleenan and Kingscourt. 1 shunt reactor on the 60km route between Kingscourt and Woodland
Total shunt compensation installed to compensate the UGC capacitance:	2000 MVar, divided between Turleenan, Kingscourt, Woodland, and the three intermediate compensation substations.

200. A number of generic topologies are available for any intermediate compensation substations, as shown in Figure 4-3.
201. Configuration (a) of Figure 4-3 gives the simplified example of a single cable core per phase connected to a single busbar. A single large compensating reactor on the busbar provides compensating current in both directions along the cable route. In practice, this arrangement would not have the full required transmission capacity for the Project. An additional disadvantage of this configuration would be that a failure of the reactor or busbar would render the complete cable circuit unusable.
202. Configuration (b) assumes that that two reactors, each approximately half the rating of that in configuration (a) are connected to the busbar. The three advantages of this are that:
- In the event of one reactor failure the other could continue to allow limited transmission capacity of the connection,
  - That the smaller reactors might more easily be delivered to rural sites, and
  - That these reactors could be identically rated to those at the terminating substations, thus reducing any strategic spares holding of compensating reactors.

203. Configuration (c) assumes two cable cores per phase and the two reactors of configuration (b) would all be connected through a single busbar, saving space, but sacrificing operational flexibility. The other advantages of configuration (b) still apply to configuration (c).
204. Configuration (d) allows the two cable cores and the two reactors to be completely electrically separate, thus ensuring that in the event of a failure on any one cable core busbar, or reactor, a full 50% capacity of the connection could be maintained. In fact, this arrangement would allow for the UGC installation to be run as two circuits instead of one for only a very minor additional percentage cost. Significant additional operational flexibility and supply security would be obtained if this option was selected. The other advantages of configuration (b) still apply to configuration (d).
205. It is impractical at this stage to recommend a firm design on the compensation for such a cable installation, and these notes just highlight some of the main options. A final design would need to take account of other compensation already available on the network, the final UGC current and voltage ratings, the availability required for the connection and strategic spares-holding policy. A typical intermediate compensation layout is given in Drawing 3 IE 19035, Appendix 8.

Figure 4-3 – Example intermediate substation topologies



### 4.3 Voltage fluctuations

206. The planning criteria in force in Ireland permit step changes in voltages in Ireland of 3%<sup>15,16</sup>. In designing the compensation it is important to ensure compensation complies with these requirements.

### 4.4 Overvoltages

207. The additional capacitance added to any system by the adoption of an UGC based solution instead of an OHL would have the effect of lowering the frequencies at which

<sup>15</sup> Transmission Planning Criteria, ESB National Grid, October 1998.

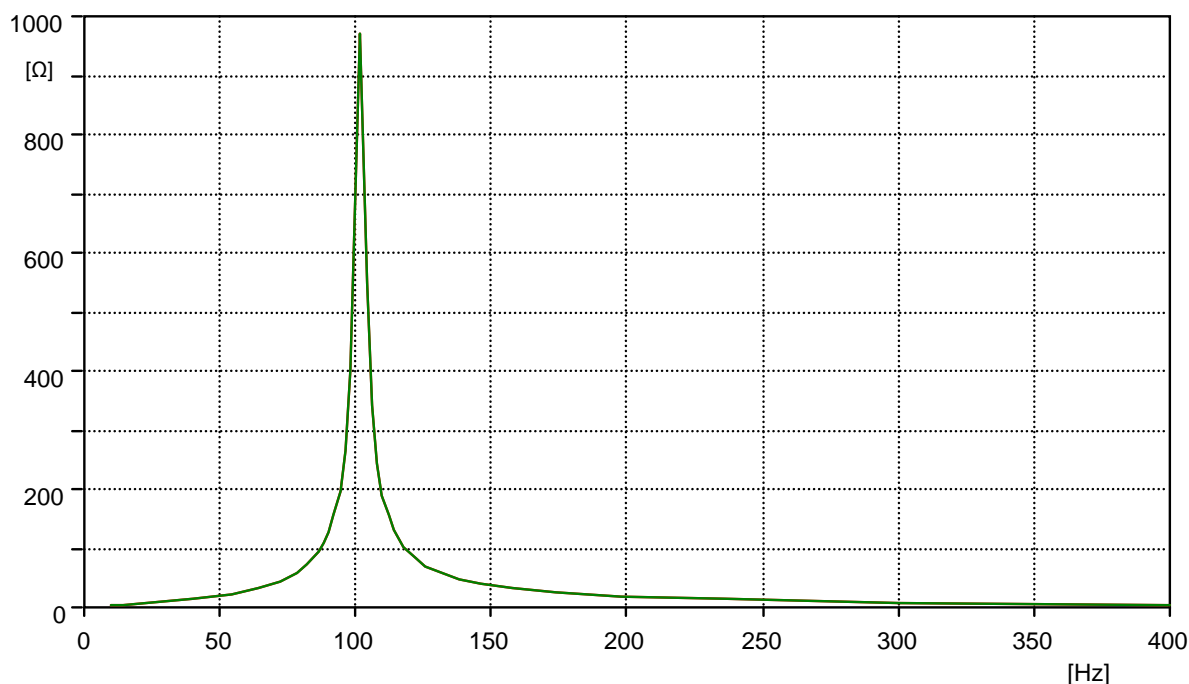
<sup>16</sup> Planning Limits for Voltage Fluctuations, Engineering Recommendation P28, Electricity Networks Association.

the system resonates. In general, the greater the length of cable added to a system, and the weaker the system, the lower are the frequencies and the more costly become the mitigating measures.

208. While this in itself is not necessarily a problem, it can become an issue if the frequencies at which the system resonates coincide with those of:
- harmonic sources on the system.
  - frequencies occurring during the energisation and de-energisation of equipment on the system.
  - frequencies occurring during fault clearing.
209. In these cases system resonance can result in equipment damage. This subject would thus require detailed investigation (beyond the scope of this report) but generally solutions to these issues can be obtained for most systems through:
- means of switching transient suppression including Point-On-Wave (POW) switching and the use of pre-insertion resistors (PIR).
  - the use of harmonic filtering techniques (e.g. use of Mechanically Switched Capacitors with Detuning Networks, MSCDN, as opposed to Mechanically Switched Capacitors, MSC).
  - Appropriate rating of equipment, particularly surge arresters.
210. A harmonic impedance plot assuming undergrounding along the whole Meath – Cavan – Tyrone route is shown in Figure 4-4.
211. Figure 4-4 indicates that, for the UGC based solution, there may well be a resonant frequency at, or close to, system second harmonic (100 Hz), causing unwanted network interactions, for example with control and protection systems. This is a situation to be avoided, since it can seriously downgrade system reliability. A detailed study of the island of Ireland transmission system would be required to assess the risks involved on this specific network and to allow the completion of a detailed UGC design. Such an assessment is beyond the scope of this report.
212. It may be noted that, for the specific transmission reinforcement in South West Connecticut<sup>17</sup> discussed in Section 3.4.4, a system-wide study of this nature was carried out. It was for system interaction reasons similar to those discussed above that it concluded that undergrounding of the route length should be limited to about 38km (24 miles), or a little over 40% of the whole route in their case.

---

<sup>17</sup> Reliability and Operability Committee (ROC) Final Report, Connecticut Light and Power, United Illuminating company, ISO New England, December 2004

**Figure 4-4 – Calculated system resonant frequency - whole route underground**

## 4.5 Electromagnetic fields (EMF)

### 4.5.1 Effect of ground clearances on EMF strengths

213. Since OHL conductors are suspended at towers, their conductors naturally sag towards the ground between these supports. Thus, OHL ground clearances of each span vary with the position along the span, being greatest at the towers, and least toward the middle of the span. Since EMFs are normally measured or calculated 1m above ground level, and assuming there were no additional factors involved, the highest levels would be found at the lowest ground clearances. The following discussion on OHL field strengths assumes OHL conductors at the minimum ground clearance of 9m.

### 4.5.2 ICNIRP EMF Exposure Guidelines

214. The International Commission on Non-Ionizing Radiation Protection (ICNIRP) is an independent scientific body comprising the essential scientific disciplines necessary to assess, together with World Health Organisation (WHO), possible adverse health effects from EMFs. ICNIRP is the formally recognized non-governmental organization in non-ionizing radiation protection for the WHO and the European Union (EU).

215. ICNIRP's "Guidelines for limiting exposure to time-varying electric, magnetic and electromagnetic fields (up to 300GHz)" was published in Health Physics, April 1998, Volume 74, Number 4:494-522. This document includes exposure guidelines relevant to the 50 Hz power frequency of the NIE and EirGrid transmission systems.

216. A conservative approach was taken in drawing up these guidelines, and a “Basic Restriction” was established by ICNIRP for the exposure of general public that is several times lower than that for occupational exposure. The Basic Restriction for exposure of the general public is that power frequency fields should not induce a current density in the central nervous system of the human torso of greater than 2 milliamps per square metre. The equivalent for occupational exposure is 10 milliamps per square metre.
217. Such exposure levels are, however, difficult to verify by direct measurement within our bodies, so ICNIRP also created a set of corresponding “Reference Levels” defined in terms of the field strengths that can be measured external to the body. The intention was that, where measured or calculated fields did not exceed these Reference Levels, compliance with the Basic Restriction could be assumed, and further investigation would not be required.
218. These Reference Level values – 5 kV/m electric field, and 100 microtesla magnetic field at power frequencies – were calculated to ensure that compliance with the Basic Restriction would still occur “under realistic worst-case exposure conditions”. This conservative approach means that in many circumstances it is possible to exceed the Reference Levels and still comply satisfactorily with the Basic Restriction. As a health and safety tool, non-compliance with the Reference Levels serves as a trigger for more detailed assessment of compliance with the Basic Restriction.
219. However, since the ICNIRP Reference Levels were set, considerable research has been undertaken to establish more accurately the electric and magnetic field strengths that correspond to the Basic Restriction. Work by Professor Peter Dimbylow, published up to and including 2005 <sup>[18]</sup> <sup>[19]</sup>, indicate that the power frequency electric and magnetic field strengths equivalent to the Basic Restriction are in the region of 9.22 kV/m and 364 microtesla respectively.
220. For convenience, these results by Dimbylow are commonly rounded down to 9 kV/m and 360 microtesla, and these rounded figures represent the prevailing guidance from the United Kingdom’s Health Protection Agency (HPA) <sup>[20]</sup> on exposure of the general public to power frequency EMFs. The same practice applies in the Republic of Ireland by implication of the recommendations in the Department of Communications, marine and Natural Resources report entitled “Health Effects of Electromagnetic Fields” that was published in 2007. These values, which may be calculated and measured in practice, are adopted in this report as equivalent to the Basic Restriction.
221. Although ICNIRP established its Basic Restriction level in 1998 it has reviewed its advice several times since. Its most recent review, published by the World Health

---

<sup>18</sup> Current densities in a 2mm resolution anatomically realistic model of the body induced by low frequency electric fields, Dimbylow P J, NRPB, Phys Med Biol, Vol 45(4), pages 1013-22 (April 2000)

<sup>19</sup> Development of the female voxel phantom, NAOMI, and its application to calculations of induced current densities and electric fields from applied low frequency magnetic and electric fields, Dimbylow P J, NRPB, Phys Med Biol, Vol 50, pages 1047-70 (February 2005)

<sup>20</sup> HPA: Application of ICNIRP Exposure Guidelines for 50 Hz Power Frequency Fields, December 2007 – [http://www.hpa.org.uk/webw/HPAweb&HPAwebStandard/HPAweb\\_C/1195733805036?p=1158934607693](http://www.hpa.org.uk/webw/HPAweb&HPAwebStandard/HPAweb_C/1195733805036?p=1158934607693)

Organisation in 2007, did not recommend any change to their previously established guideline levels.

#### 4.5.3 Guidelines Adopted

222. The EU Council endorsed the ICNIRP Guidelines <sup>[21]</sup>, and formally adopted "... a framework of Basic Restrictions and Reference Levels" (Recommendation II(a)), "and taking account of the risks and benefits of action". One aspect of this balance of risks and benefits was considered to be the duration of the exposure to the EMFs. On this point, Recommendation II(b) says that Member States should "... implement the measures according to this framework, in respect of sources or practices giving rise to electromagnetic exposure of the general public when the time exposure is significant ...".
223. NIE and EirGrid have both adopted the EU Council Recommendation 1999/519/EC and the ICNIRP exposure guidelines that it embraces.

#### 4.5.4 Electric fields

224. Whilst underground cables do not emit electric fields, overhead lines do. The strength of these OHL electric fields are dependent upon a number of factors including the design of the overhead line, the system voltage, and the proximity of any shielding object, for example trees, hedges, buildings and fences.
225. The proposed overhead line has a nominal system voltage of 400kV. During operation, the system voltage would fluctuate above and below the nominal voltage, but would never normally be allowed to vary above nominal by more than 5%. The maximum electric field strengths likely to be found in the vicinity of the proposed OHL are thus calculated assuming a system voltage of 420kV, and are presented in Table 4-5. Normally, however, field strengths would be lower than those shown, since running the network at 420kV is unusual.
226. The same table also provides, for comparison, that electric field strength which is considered to be equivalent to the ICNIRP Basic Restriction already discussed.

---

<sup>21</sup> Council of the European Union: Council Recommendation of 12 July 1999 on the limitation of exposure of the general public to electromagnetic fields (0 Hz to 300 GHz)" (1999/519/EC)

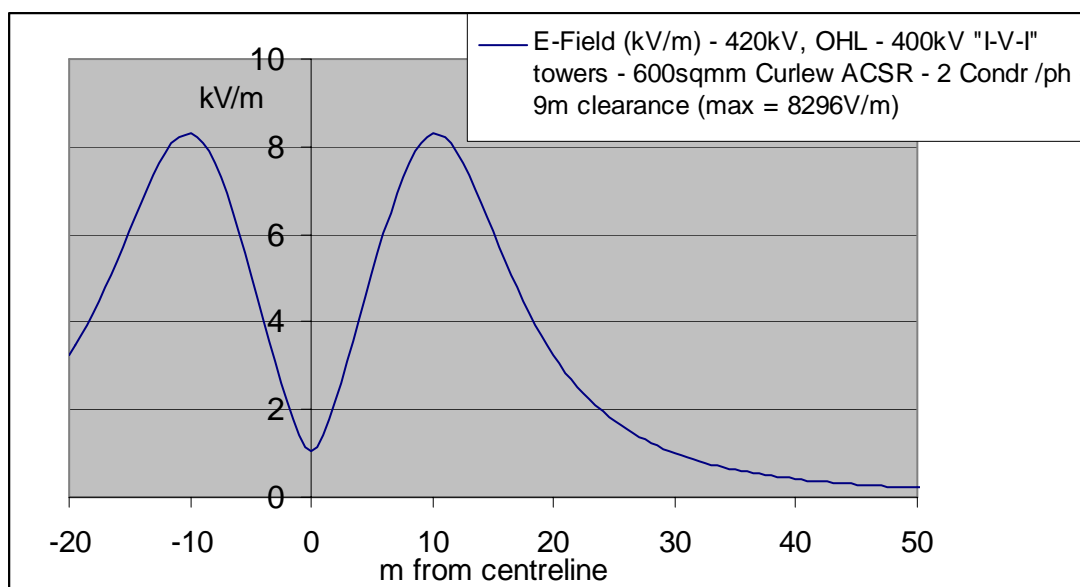


**Table 4-5 –OHL electric field strength calculations, 1 m above ground**

Distance from the OHL centre-line (m)	OHL at 420kV, 9m ground clearance (kV/m)
0	1.0
5	5.1
10	8.3 (max)
25	1.7
50	0.2
ICNIRP “Basic Restriction” for general public	9

227. Figure 4-5 shows this same information graphically. It may be seen that the electric field strength has reduced to one tenth of its maximum about 35 m from the centreline of the OHL.

**Figure 4-5- Variation of OHL electric field strength with distance from centre-line**



#### 4.5.5 Magnetic fields

228. The strength of magnetic fields vary in proportion to the electrical load being carried by the circuit at any given instant. Maximum field strengths therefore occur at the times that the line is fully loaded. Table 4-6 illustrates this variation with load for an

OHL and for a 2-cores-per-phase UGC of the type described in Section 3.5. It is assumed here that the UGC phases will be laid in “mirror” formation (R - Y - B --- B - Y - R). Field strengths are calculated for 1 metre above ground for full rated load of the circuit, 1500MVA, for half full-load, and for a more generally anticipated typical load of 500MVA.

229. The same table also provides, for comparison, that magnetic field strength equivalent to the ICNIRP Basic Restriction.

**Table 4-6 – Magnetic field – variation with electrical load**

Load (MVA)	OHL, 9m ground clearance (microtesla)	UGC, 1.05m burial depth (microtesla)
500 (typical)	16	23
750	24	34
1500 (max)	48	68
ICNIRP “Basic Restriction” for general public		360

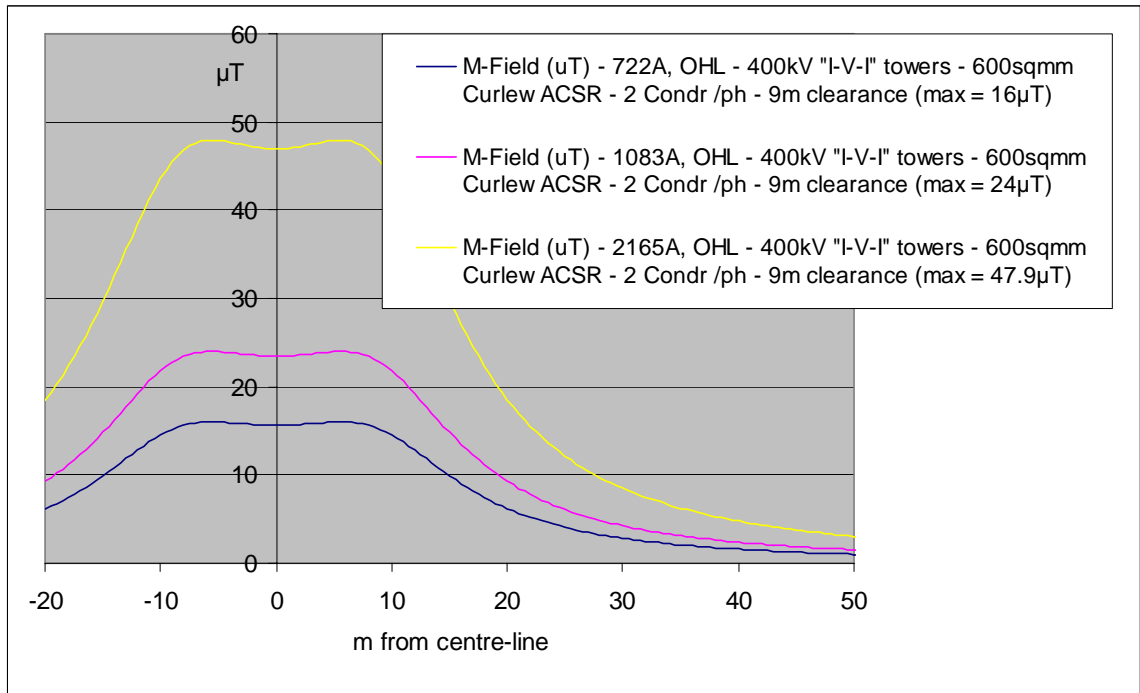
230. In addition to temporal fluctuations with load, however, magnetic fields also vary with distance from the route centre-line. Table 4-7 shows calculations of this variation with distance from the route centre-line, again for 1 metre above ground.

**Table 4-7 – Magnetic field – variation with distance from centre-line**

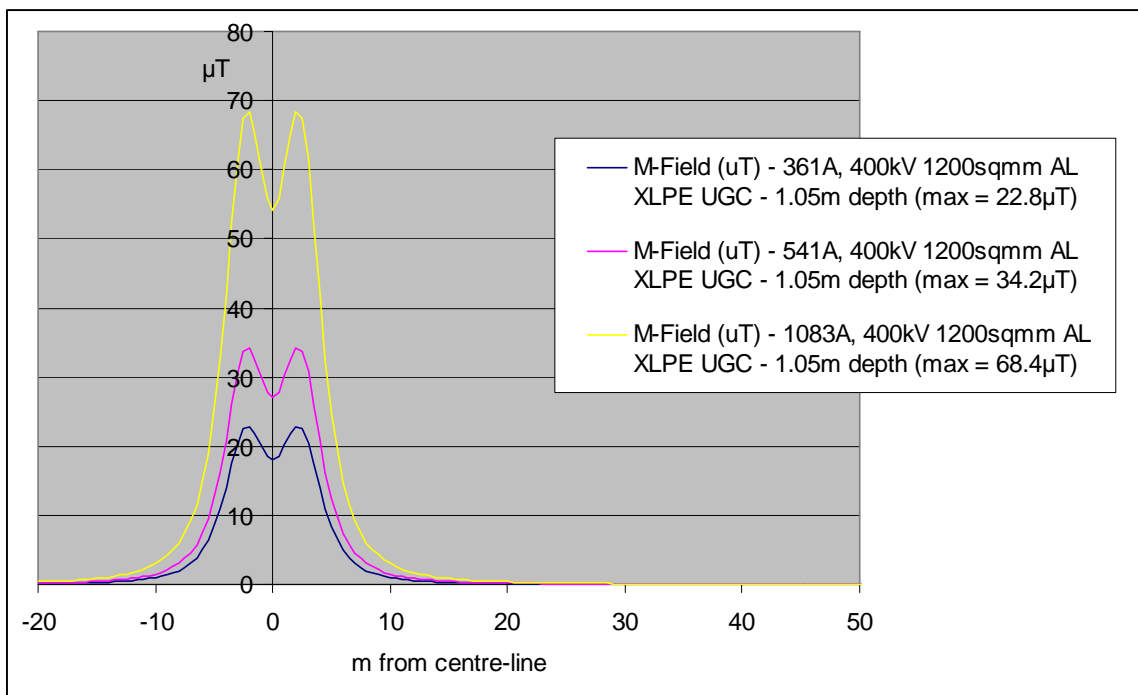
Distance from route centre-line (m)	OHL, 9m ground clearance (microtesla)	UGC, 1.05m burial depth (microtesla)
0	16	18
2	16	23 (max)
5.5	16 (max)	6
10	14	1
20	6	0.1
ICNIRP “Basic Restriction” for general public		360

231. Figure 4-6 and Figure 4-7 show this same information graphically. By comparing these two graphs it may be seen that the field strengths from the UGC decrease more quickly with distance than those of the OHL, although the maximum field strengths for a given load are greater for the UGC.

**Figure 4-6- Variation of OHL magnetic field strength with distance from centre-line**

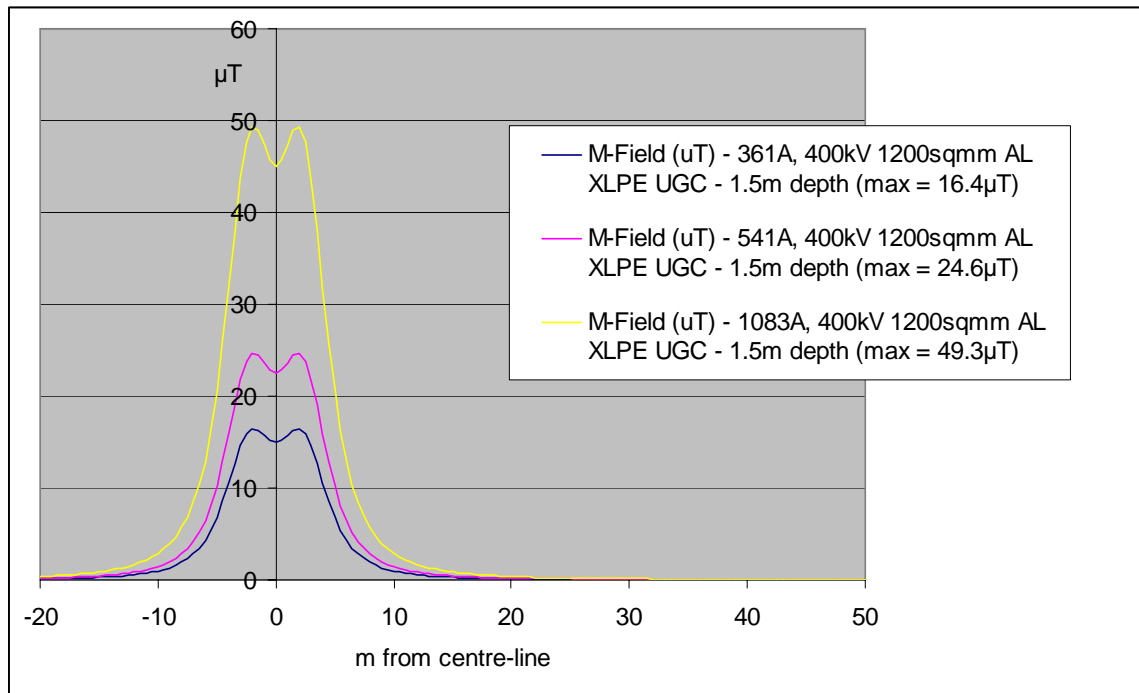


**Figure 4-7- Variation of UGC magnetic field strength with distance (depth 1.05m)**



232. All else being equal, the field strengths from an UGC would be lower the deeper it is buried. However, this lower field strength would represent a considerable increase in installation cost since, not only would there be nearly a 50% increase in trench material handling, but larger cables may be required to maintain thermal rating. Figure 4-8 presents the magnetic field strengths from the same UGC and electrical loads, but with a greater burial depth.

**Figure 4-8- Variation of UGC magnetic field strength with distance (depth 1.5m)**



#### 4.6 Electrical Losses

233. Whenever current flows through a circuit, be it OHL or UGC, heat energy will be generated in proportion to the resistance of the conductor and the square of the magnitude of the current.
234. Any heat energy that is produced in this way is dissipated into the atmosphere and lost. It thus reduces the electrical energy that is available to the customer, which has two significant, but separate, implications for the electricity supply system. Firstly, it means that extra fuel has to be used at the generating stations to make up for the energy that has been lost to the atmosphere and was never delivered to the customer. Secondly it means that extra generating stations have to be built to ensure that consumers do not suffer power failures during the peak load periods (usually, in Ireland, the early evenings during the winter).
235. Currents flow in transmission circuit conductors for several reasons, and all of these lead to losses, and therefore to additional costs of the supply of electricity. Some losses vary with the electrical load that is being transmitted, whilst others are relatively steady, depending upon the system voltage. In comparing the costs of OHL and UGC this study has taken into account costs of the following losses:

- Load dependent losses (losses that vary with the load at a given instant)
  - Voltage dependent losses in the transmission circuit - both capacitance charging and dielectric (or “tan  $\delta$ ”) losses. (It should be noted that charging current losses in long circuits can reduce the effective load that can be transmitted.)
  - Voltage dependent losses associated with reactive compensation equipment (shunt reactors) which is only required in the case of UGC connection.
236. Losses are also discussed in Sections 3.5.3 and 6.11 of this report. PB Power’s treatment of the OHL and UGC costs of these losses is described further in Sections 8.3.2.2 and 0 respectively.

#### 4.7 Operational issues

237. The use of UGC circuits instead of overhead line for a 140 km connection has a number of operational effects:
- **Complexity and modes of failure:** The complexity of the system and modes of failure are increased by the addition of equipment at intermediate substations including:
    - a. High Voltage switchgear and connections,
    - b. Shunt reactors and associated cooling systems,
    - c. Protection systems,
    - d. Control systems,
    - e. Auxiliary power supplies, and systems to each extra substation.
  - **Operational complexity:** The increased complexity of the system places an increased burden on the system operators,
  - **Controllability:** It will be necessary to design the compensation to ensure controllability at all times and under a wide variety of system conditions. This may require part of the compensation to be dynamic, by making use of Static Var Compensators for example.
238. Complexity and additional equipment introduced by any of the above listed aspects tends to reduce reliability, thus the overall reliability of the proposed connection would be reduced if it were to be constructed with UGC as opposed to OHL.

#### 4.8 Flexibility

239. A notable long-term advantage of OHL in comparison with UGC is the relative flexibility of the former when considering later changes to system configuration. For example, upgrades to the current carrying capacity of the conductors to accommodate load growth, is much simpler with an OHL than with an UGC. Equally, raising the circuit voltage to reinforce the local network is much more easily

accomplished with OHL. Modifications to the system topology, for example the connection of a new substation or transformer, may be achieved over a much shorter outage time to an OHL than to an UGC.

#### 4.9 Conclusions

240. Robust reliability statistics for transmission OHL and UGC are difficult to obtain for a number of reasons. However, overhead lines are susceptible to environmental effects and thus normally exhibit fault rates higher than those of cable circuits. An underground cable circuit is thus normally more reliable than its equivalent overhead line.
241. However, average repair times for cables are much higher than those for OHL, being measured in weeks rather than hours. From European statistics, availability over the long term of 140 km OHL would be expected to be around 99.8% pa compared to 90.3% for the same length of UGC. Two such UGC circuits in parallel (as could be chosen if the UGC installation comprised 2 cores per phase) would be expected to achieve 99.1% between them.
242. Thus, even a double circuit UGC performance would not match that of the single circuit OHL, having an expected unavailability of 0.9%, that is, 4.5 times worse than the 0.2% unavailability of the OHL.
243. System security all over Europe relies upon the relatively high availabilities provided by OHL networks. The introduction of significant quantities of UGC in strategic transmission routes may thus compromise system security to the extent that additional circuits may need to be built.
244. Significant reactive compensation would be required for the Project if an UGC solution was to be chosen. Many alternative designs are practicable, but the assumptions of this report allow for relatively small compensator installations at each of the three substations and at three intermediate locations along the 140 km route. This approach would facilitate transport into locations remote from major roads and would tend to reduce the cost of cable insulation (because peak operating voltages along the circuit would be lower). In addition, it would simplify any strategic spares strategy for this important part of the installation.
245. The additional capacitance added to any system by UGC would have the effect of lowering the frequencies at which the system resonates. System resonance can result in equipment damage, so detailed design would need to ensure that appropriate solutions are included within the Project design. There is a potential impact on a total UGC project cost of up to 2% or 3%.
246. OHL produces power frequency electric fields which are relatively stable in time. The proposed OHL would produce a maximum field strength of around 8.3 kV/m, which is lower than the European and Irish adopted ICNIRP Basic Restriction guideline limit of 9 kV/m. The field strength would drop to about one tenth of its maximum at about 35 m from the centreline of the OHL.

247. Both OHL and UGC produce power frequency magnetic fields whose strengths would be directly proportional to the electrical load being carried at any instant. The magnetic fields from the OHL and the UGC would have maximum strengths (at full load) of around 48 $\mu$ T and 68 $\mu$ T respectively. These are both much lower than the European and Irish adopted ICNIRP Basic Restriction guideline limit of 360 $\mu$ T. Under normal circumstances the maximum magnetic field strengths to be found near the circuit would be much lower than these maxima, since the circuit would only run at full load under emergency conditions. Moving away from the centreline of the circuit, the OHL and UGC field strengths would have dropped to one tenth of their values at around 45 m and 8 m respectively.
248. Long UGC installations can have a negative impact upon system complexity, due to the introduction of circuit ancillary equipment, including reactive compensation and associated protection systems.
249. OHL is seen to be much more flexible over the long term than UGC. Upgrades to OHL current carrying capacity or circuit voltage, and modifications to the system topology, would be at lower cost and would require shorter outages than would be the case for UGC.

## 5. OVERVIEW OF HVDC CONNECTIONS

### 5.1 HVDC experience

250. HVDC transmission has been used commercially since 1954, when a DC transmission link was put in service between the Swedish mainland and the island of Gotland. The relatively long distance cable (100 km) for this application made HVDC transmission more technically viable and economic than HVAC.
251. To date HVDC transmission has been used for more than 70 different projects. The largest HVDC scheme has a capacity of 6300MW (2 bipoles<sup>22</sup>) and operates with a voltage of  $\pm 600\text{kVdc}$ . The smallest scheme has a rating of 50MW. The technology for a  $\pm 800\text{kVdc}$  link is currently being developed.
252. HVAC remains the primary medium for general transmission and distribution of electrical energy, but HVDC has proved to be an economic means of power transmission in a few specialist circumstances, major examples being:
- Long distance overland OHL transmission (greater than about 800 km), either from a remote bulk power source to a load centre, or for long circuits between or within networks,
  - Long submarine cable crossings (greater than about 80 km), and
  - Interconnections between asynchronous networks.

### 5.2 HVDC transmission technology

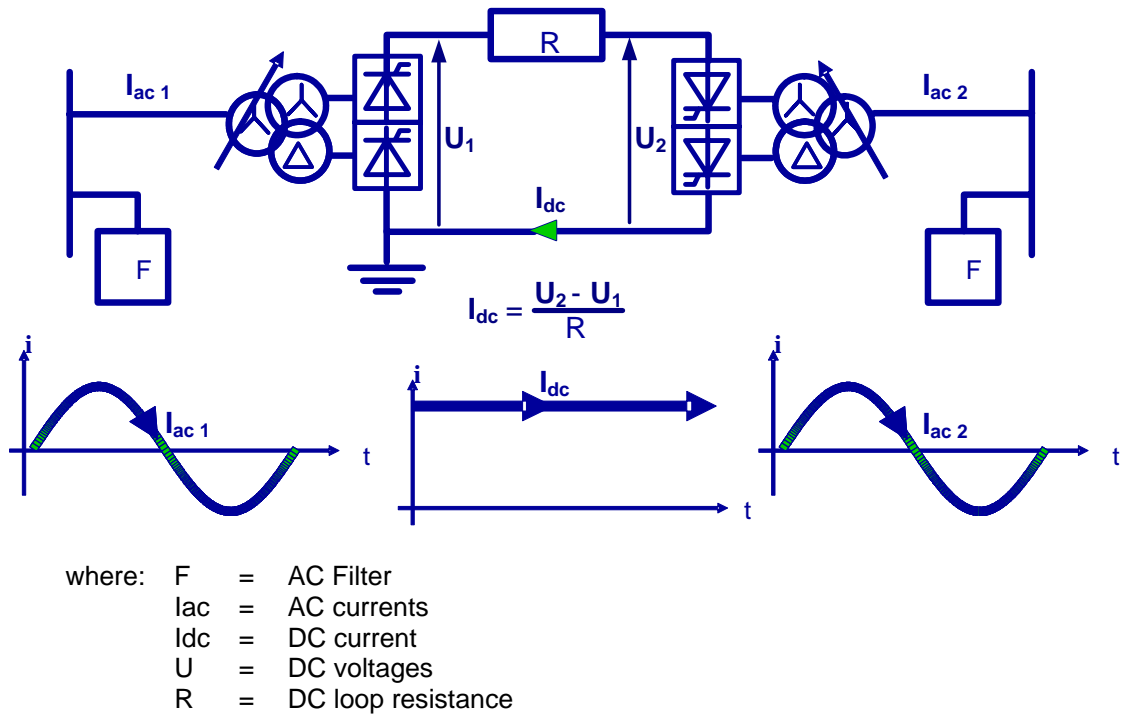
253. A HVDC transmission scheme typically transmits power between two points (“terminals” or “converter stations”), which may both be in the same network, or may be in different AC networks. Multi-terminal HVDC schemes exist, but these are not the norm, and their special design will be discussed only briefly, later in this report.
254. The power flow between the terminals in an HVDC scheme depends simply upon the voltage difference between the two terminals and the resistance in the DC loop. The phase angle and voltage magnitude at the AC terminals of the HVDC scheme play no role in determining the steady state power flow between the terminals of the HVDC scheme. Figure 5-1 shows an example schematic diagram of an HVDC link.

---

<sup>22</sup> Bipoles are discussed further at Section 5.3.2



Figure 5-1- Example schematic diagram of an HVDC Link



255. In an HVDC transmission scheme converter stations are used to convert alternating current and alternating voltage to direct current and direct voltage at one end and vice versa at the other end. Typically, one converter station will control the direct voltage, and the other will control the power transmitted between the terminals. Since transmission of power between the two converter stations is by means of direct current and direct voltage, no reactive power flows occur on the direct current (DC) side.
256. The conversion between AC and DC is performed with semi-conductor switches, which are controlled in accordance with various control criteria and algorithms implemented in the control system. The control of the power flow between the two converters is very fast, and the power flow can be modulated in response to events and disturbances in the AC network, to provide benefits to the AC networks at either end of the HVDC scheme. It is important to note, however, that DC connections do not intrinsically behave like AC connections, and considerable control system complexity is required to fully integrate a DC link within an AC network.
257. Two different technologies are available today for the conversion between AC and DC:
- Thyristor based, Line Commutated Converter (LCC) technology, which is the original ("Classic") implementation of HVDC schemes, and which will be referred to as LCC HVDC in this report.
  - Integrated Gate Bi-polar Transistor (IGBT) based, Voltage Sourced Converter (VSC) technology, which has been in commercial use since 1999. This approach will be referred to as VSC HVDC in this report.

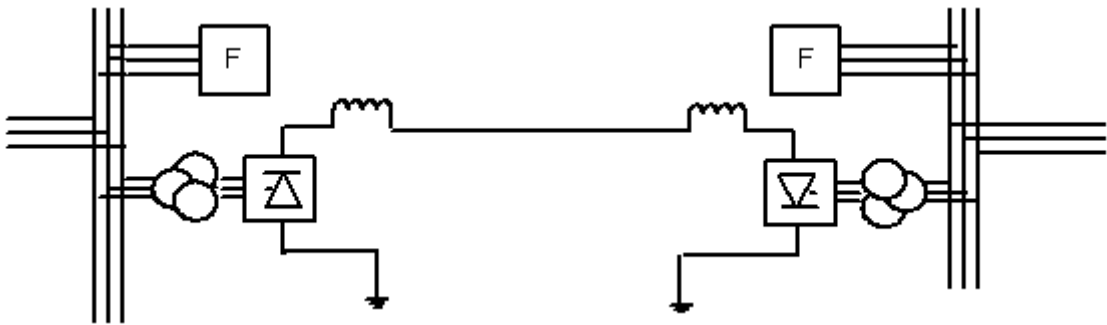
### 5.3 HVDC connection arrangements

258. HVDC technology can be deployed in a number of different configurations, with the choice of configuration on a particular scheme depending on the power rating and the reliability/availability required for a particular scheme. This next section describes some different configurations. The descriptions are largely technology independent, but where appropriate, specifics associated with the different technologies are discussed.

#### 5.3.1 Monopolar HVDC

259. A monopolar HVDC transmission is often considered to be the equivalent of a single circuit AC transmission link. Figure 5-2 shows a simplified diagram of a monopolar HVDC scheme, which uses one high voltage conductor and earth electrodes for the return current.

**Figure 5-2 - Simplified diagram of monopolar HVDC link with Earth return**

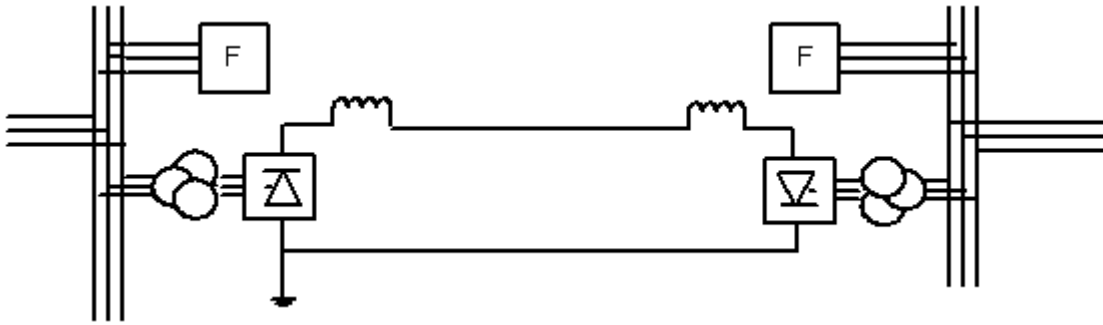


260. This type of installation is the simplest possible implementation of a HVDC transmission link, and therefore provides the lowest capital cost and typically also the lowest power loss. However, since there is only one set of fully rated equipment at each end of the scheme, and since all equipment is necessary for the exchange of power between the two ends, an outage of any part of the equipment results in a complete cessation of power transmission.

261. In many parts of Europe and other parts of the world, getting permission for new schemes to use earth return is likely to be very difficult and time consuming. One of the issues associated with the use of earth return is the stray direct current, which may be picked up by large metallic objects, such as pipe lines, railway lines or cables. The stray current flowing in such objects can cause significant corrosion, unless appropriate counter measures are taken

262. An alternative arrangement of the monopolar scheme, which avoids the issues of stray direct current in the ground is shown in Figure 5-3.

Figure 5-3 - Monopolar link with metallic return

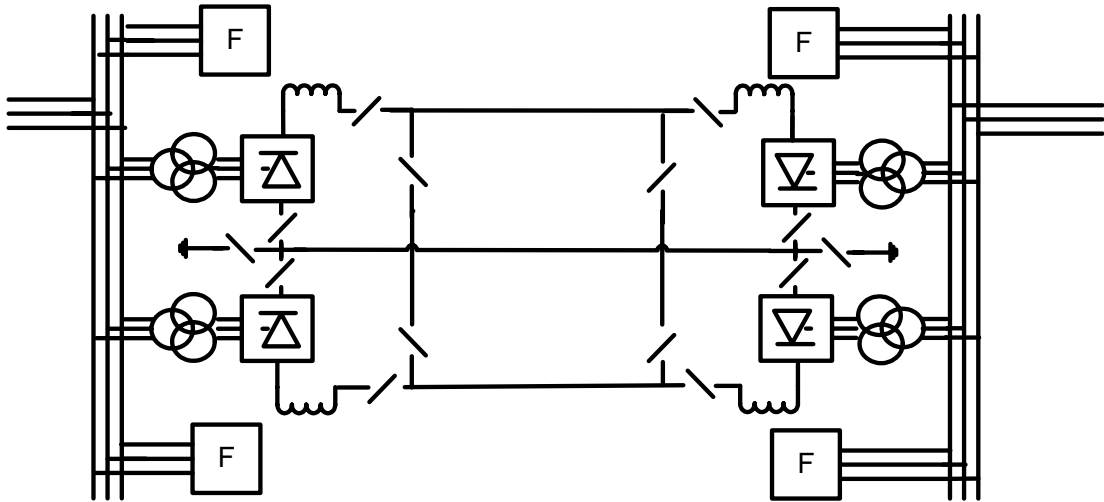


263. The metallic return arrangement of the monopolar scheme uses a separate low voltage conductor for the return current. The DC circuit is earthed in one location only, which avoids stray direct current flowing in the ground between the two terminals.

### 5.3.2 Bipolar HVDC transmission

264. Since the converter equipment is more complex and has more components than the transmission line, the outage rate of the converter is likely to be higher than that of the line itself. In order to maintain the reliability of the transmission system, therefore, redundancy and duplication are built into most major transmission projects, such that some equipment failures can be tolerated without loss of supply to the customer. Such redundancy and duplication in the HVDC system may be provided with bipolar transmission.
265. **A note on availability:** Before discussion bipolar transmission further it should be recognised that, in order to benefit from the system duplication discussed in the previous paragraph, it is important to minimise the time that failed equipment is out of service by giving careful consideration and adequate budget to the strategic spares holding of all purpose made equipment in the HVDC link.
266. Figure 5-4 shows a bipolar HVDC transmission link, which may be considered to be the equivalent of a double circuit AC transmission connection. A bipolar installation uses two mono-poles, connected in such a way that one is operating with positive polarity and the other with negative polarity, and with the direct current in the two poles typically being identical, during normal operating conditions. Assuming that earth return operation is not permitted, even for short periods, a neutral return cable is normally provided. In the event of a problem or outage with one of the poles, power transmission can continue at 50% capacity, using the remaining pole, provided that suitable DC switchgear and transmission line facilities have been provided.

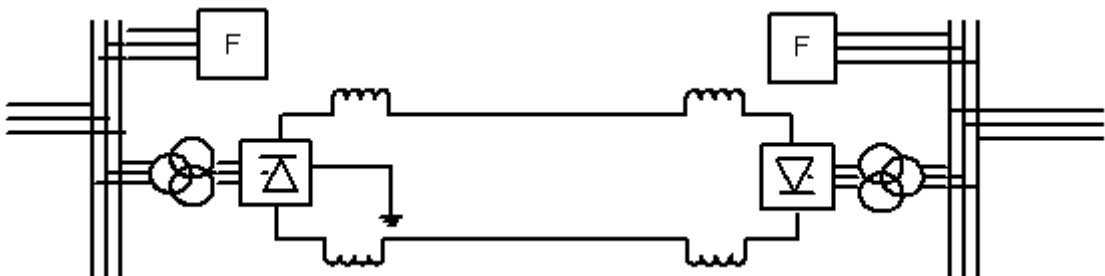
**Figure 5-4 - Bipolar scheme with metallic return for the unbalance current**



### 5.3.3 Modified bipole

267. For applications where earth current is not acceptable, and where the Reliability and Availability of a mono-pole is adequate, an arrangement as shown in Figure 5-5 may be adopted.

**Figure 5-5 - Modified Bipolar Arrangement**



268. This arrangement uses two fully insulated high voltage cables and a single converter at each end. This arrangement has been used for back to back schemes and for the NorNed HVDC cable connection. Since the DC terminal to terminal voltage can be relatively high, the cable current can be kept low, and power losses in the cable are correspondingly reduced.

### 5.3.4 Multi-Terminal HVDC Schemes

269. Most HVDC schemes are implemented as two-terminal end-to-end transmission links, either within a network, or between networks. However, it is possible to design a HVDC scheme with more than two terminals.
270. Two such LCC HVDC schemes have been designed and are in operation in the world. However, AC disturbances and transients at any one of the terminals adversely affects the performance of the complete HVDC link, and track performance to date is poor.

271. VSC transmission schemes would not suffer from commutation failures in the same way, however, to date there is no multi-terminal VSC operational track record.

#### 5.4 HVDC overhead lines

272. The overhead line technology used in HVDC connections is well proven at service voltages up to  $\pm 600\text{kV}$  for transfers of up to about 3000MW for distances up to 1800 km. There are many tower design philosophies depending on the requirements for:

- Mono-pole or bi-pole configuration, and
- With or without earth return.

273. HVDC overhead lines can be designed to have a similar performance to HVAC overhead lines, however, given the uni-directional nature of the field in HVDC applications, pollution build-up on insulators tends to be more problematic. There also tend to be differences in tower height and capital cost.

#### 5.5 HVDC cables

274. The cable technology used in HVDC links may be classified as follows:

- **Single core cables.** The proven capacity limit of single core mass impregnated cable that can be provided by European manufacturers is presently set at 450kV DC and 1400A DC corresponding to a maximum pole rating of 630MW and maximum bipole rating of 1260MW. A number of HVDC interconnectors have been recently commissioned using these types of cable (for example Greece-Italy 400kV DC 1250A, and Victoria-Tasmania 400kV DC 1500A), with no adverse service experience or major problems reported to date. The NorNed scheme, which is presently under construction, uses a modified mono-pole configuration and comprises two cables operating at  $\pm 450\text{kV}$  with a rating of 700MW and length of 580 km.
- **Polymeric cables** such as cross linked polyethylene (XLPE) cost less than mass impregnated cable. However, XLPE insulation cannot withstand periodic polarity reversal, so it cannot be used in typical LCC applications. However, it can be used in VSC transmission applications where the diodes prevent polarity reversal. To date, these cables have been applied at voltages of up to  $\pm 150\text{kVdc}$ .

## 6. SYSTEM CONSIDERATIONS FOR HVDC SOLUTIONS

275. Detailed analysis of the DC solution is beyond the scope of this report. In general, however, HVDC requires a considerable amount of HVAC equipment to integrate with an HVAC system, resulting in a sizeable converter station installation at each of its connecting points to the HVAC network (see drawing 3 IE 19038, Appendix 8, for a typical HVDC converter station layout). Its successful application depends upon complex (but well understood) programming of its control systems to allow it to appropriately respond to the AC system. What follows is a general introduction to some of the key system considerations when providing an HVDC connection.

### 6.1 Availability and reliability

276. Data on the availability of HVDC schemes has been collected by CIGRE<sup>23</sup> since 1968.
277. Scheduled outages (planned) for HVDC installations are primarily required for the regular maintenance requirement of each converter pole which, according to the CIGRE world statistics<sup>[24]</sup> amounted to an average planned unavailability of about 8.7 days per pole per annum. In a bipole scheme the two poles are usually taken out of service one by one, such that power transmission at 50% of the installed capacity can continue during the maintenance period.
278. Forced outages (un-planned) occur when the HVDC link is unable to deliver the energy that has been requested by the system operators. Again, according to the latest CIGRE statistics, the average unplanned unavailability is about 1.9 days per annum
279. Taking these average planned and un-planned unavailabilities together, the expected overall HVDC converter station performance, as recorded by CIGRE, would be as shown in Table 6-1.

**Table 6-1 – HVDC Converter Performance – Overall Unavailability**

HVDC LCC	2.9%, equivalent to 10.6 days pa in total
HVDC VSC	No verified CIGRE figures available, but understood to be approaching the LCC performance in recent installations

280. Strategic spares holding bears directly on actual availability of an HVDC link. There are many major items of equipment in an HVDC installation that are unique to HVDC, possibly unique to the particular HVDC link, and which nevertheless would require a

<sup>23</sup> CIGRE - The International Council on Large Electric Systems

<sup>24</sup> CIGRE 2008 – Derived from Table I of B4-119 A Survey of the Reliability of HVDC Systems Throughout the World During 2005 - 2006

strategic spares holding in order to maintain the availability performance quoted. Larger items to be considered for this spares holding would include the HVAC converter transformers as well as selected HVDC equipment. Since these are unlikely to be held in stock already (unless equipment design can be harmonised with existing HVDC links owned by NIE and EirGrid) then additional cost, over and above the installation itself would be incurred in establishing this spares holding.

## **6.2 System strength**

281. LCC HVDC systems rely on the presence of a sinusoidal AC voltage waveshape at its terminals for its satisfactory and reliable operation. Since the LCC HVDC converter introduces a small disturbance to the network a minimum network short circuit level to converter rating ratio of 2.5 or more for stable operation is usually necessary.
282. VSC converters can operate satisfactorily at fault levels below that at which LCC can be used. In fact they can deliver power to a passive network without active power generation.

## **6.3 Reactive power**

283. LCC HVDC systems absorb reactive power. The level of compensation required to control the AC voltage depends upon several factors, but shunt capacitors and AC harmonic filters together are typically rated (MVar) at about 50% of the active power transfer. These reactors would be situated at the HVDC converter stations.

## **6.4 Harmonics and flicker**

284. Potentially damaging harmonics produced by the converter operation need to be filtered out to avoid them penetrating the AC network. The need for AC harmonic filtering is substantial, and these filters would be installed at the HVDC converter stations. However, since filtering this requirement varies with the level of power transmission, the reactive power compensation that the filters also provide at the fundamental frequency usually results in a surplus of reactive power generation at low load. Shunt reactors may thus also be required at the HVDC converter stations.

## **6.5 Overvoltages**

285. For a LCC HVDC scheme the reactive power capacitor banks and AC harmonic filters would be a potential source of damaging AC overvoltages during faults. Further additional specialised equipment would thus be required at the HVDC converter stations to avoid these overvoltages.
286. VSC transmission schemes are generally less susceptible to this overvoltage problem.

## **6.6 Steady state and transient stability**

287. The transmission connection of this Project would be operated in parallel with other AC transmission links. Unlike HVAC however, the power flow on a HVDC scheme is determined by the converter control systems and not by the phase angle difference

between the sending and receiving end voltages. A HVDC scheme would thus require programming specific to the HVAC network in order to ensure appropriate response to events such as fault tripping of lines or generators. Such programming would introduce additional system complexity to the existing HVAC network.

## **6.7 System performance with multiple HVDC systems**

288. When HVDC schemes terminate electrically close to each other there is a risk that the converters may adversely interact with each other, unless the issue of interaction has been carefully considered in the design of the schemes. These problems are avoided by co-ordination of the HVDC link control schemes, but of course this factor adds considerable design, construction and operational complexities. This consideration would be particularly relevant for this application since there would be substantial HVDC links to the UK mainland at both ends of the Project.

## **6.8 Sub-synchronous torsional interactions between HVDC link and generators**

289. There are two separate mechanisms that can excite sub-synchronous torsional oscillations on the shafts of generators connected to the AC system at locations close to the DC converter stations. Once identified, however, these issues may be avoided by incorporating appropriate damping algorithms into the HVDC controls.

## **6.9 Design Complexity**

290. Complexity in the context of the HVDC converter would be introduced by the reactive compensation and harmonic filtering provisions mentioned above, but these areas do not represent the full extent of the issues to be solved when interfacing HVDC with AC networks. There are many other complexities, including in particular the DC control strategy and implementing control mechanisms, and the effects on the HVAC network of reactive compensation associated with the HVDC. The thorough investigation and resolution of all the design issues associated with the operation of both of the existing AC transmission systems with an HVDC link would thus be an essential requirement in the very early design stages.

291. The design issues associated with integrating a 1500MW HVDC link as a connector between two relatively small AC networks, with high wind-power penetration and limited frequency-response plant, is outside the scope of this report, and is being considered separately.

## **6.10 Operational issues for HVDC**

### **6.10.1 Power reversal capability**

292. Power reversals using LCC technology and mass impregnated HVDC UGC would be restricted to about 6 per day due to the limited capacity of the cable to accommodate the associated voltage reversals. This restriction would not apply to LCC HVDC OHL, nor to VSC transmission schemes which change direction of power flow by reversing the direct current rather than the voltage.



### 6.10.2 Minimum HVDC power transfer

293. LCC HVDC link continuous operation at power transfers below about 5-10% is typically time limited or disallowed.
294. On a VSC transmission installation the higher switching speed and therefore higher harmonics orders means that there would be no practical minimum power transfer.

### 6.10.3 HVDC control arrangements

295. HVDC converters have the ability to run-up/run-down between full load and minimum load in less than one second. However, for a LCC HVDC link, the requirement to switch AC harmonic filter banks in order to control the AC voltage at the terminals during power ramping, may result in a slower ramp rate, particularly for weak AC systems. A VSC transmission scheme would not require filter switching to control the AC voltage.

## 6.11 HVDC Losses

296. Losses constitute a significant component of the life time costs of transmission circuits. For a HVDC installation losses occur both in the converter stations and in the OHL or UGC circuit. Whilst the circuit losses are typically less for the HVDC scheme than for an HVAC scheme, the losses in the converter station are typically several times higher than those in an equivalent AC substation.
297. Losses are lower in an HVDC circuit than in an equivalent HVAC circuit firstly because there is no skin effect for the DC current flow and secondly because there is no reactive power flow in the DC circuit. Because reactive power flow in HVAC connections increases with circuit length, the difference in the power loss between HVAC and HVDC also increases with the length of the circuit.
298. Losses in a HVDC transmission circuit vary as the square of the power transmitted, whereas for HVAC circuits there are fixed losses components even before power is transmitted.
299. Converter station losses have a component which varies linearly with transmitted power, a component that varies with the square of the transmitted power, and a component that does not vary with the transmitted power at all. These variations are different for LCC and VSC HVDC transmission, the VSC transmission having a higher invariable loss and a lower current squared dependent component. The losses of two HVDC converter stations together at full load and operation at unity power factor is typically 1.7% and 3.8% for the LCC HVDC scheme and the VSC transmission scheme respectively.
300. Losses are also discussed in Sections 3.5.3 and 4.6 of this report. PB Power's treatment of the OHL and UGC costs of these losses is described further in Sections 8.3.2.2 and 0 respectively.

## 6.12 Future flexibility of HVDC

301. HVDC lends itself to long distance point-to-point bulk transfers of energy and to the connection of asynchronous AC networks. However, whilst it would be possible to tap into HVDC connections to create intermediate terminals, the present track record for such arrangements is not encouraging.
302. In addition to the questionable track record for multi terminal HVDC links, intermediate tap-off terminals also tend to be relatively expensive because they must all be rated for the full DC voltage and the fault current of the installation.
303. Thus an HVDC solution cannot be considered to provide the same level of flexibility as an AC transmission solution for future intermediate connections.

## 6.13 Environmental Issues

304. Some aspects of the environmental impact of HVDC transmission are mentioned briefly below. In addition, the reader is referred to Sections 3.7 and 7.3.3 where the impacts listed would also apply to an HVDC UGC installation.
305. There are no standards for DC electric and magnetic fields emanating from overhead lines. However, the earth's magnetic field varies between 30 to 60 microtesla so any field strengths less than this level would be totally indistinguishable from that experienced by everyone on a daily basis. It would be expected that, for HVDC cables placed less than 0.5m apart, the magnetic field resulting from full load operation 1m above ground level would be of the same order of magnitude as the earth's magnetic field.
306. The main sources of acoustic noise for a converter station during operation are:
  - a. Converter Transformers
  - b. Converter valve cooling plant
  - c. Filter Inductors and capacitors
  - d. DC Reactors.
307. If acoustic enclosures were to be required to limit the converter station noise, this may add considerably to the cost of the converter station.
308. The impact of the HVAC/HVDC converter substation on visual amenity, close to the site, may also be a consideration. An example converter station layout for a 1500MW bipole is provided in Drawing 3-IE-19038, Appendix 8. This shows a site area of about 240m x 180m = 43,000m<sup>2</sup>. Some buildings on the site would typically be around 20m high. The use of gas insulated switchgear (GIS) would reduce this by about 30%. The example layout also assumes connection to an HVDC UGC and additional land area would be required for an OHL based HVDC connection.

## 6.14 Project programme

309. The implementation time for the converter stations for a large HVDC Interconnector is typically 30 to 36 months depending on the rating and complexity, not including land negotiations.

310. The programme timing for an underground HVDC cable depends on the manufacturing time for the cable and on the time required for laying the cable. The manufacturing capability of the largest European cable manufacturer for mass impregnated paper insulated cables is presently about the same as for XLPE UGC, namely around 10 km/month. This issue of UGC manufacturing lead time is further discussed at Section 3.6.

### **6.15 Conclusions on HVDC Technology**

311. Successful application HVDC transmission within a meshed all-island network would depend upon a considerable amount of HVAC equipment and a sizeable converter station installation at each of its connecting points to the HVAC network
312. Complex control algorithms would be required to allow it to respond appropriately to the conditions of the existing AC network. For this, and other reasons, an HVDC solution would introduce more system complexity than an HVAC OHL.
313. HVDC terminal stations would require more planned maintenance outages than their HVAC equivalents. In addition to any equipment failures, system operators would need to plan for around 18 days each year when the HVDC bipole link would be running at 50% capacity, and around a further 2 days each year when it would not operate.
314. The proposed Project would double the Northern Ireland - Republic of Ireland interconnector capacity so, during any period when the Project connection is out of service, the available interconnector transfer capacity would be halved. In this circumstance the significant annual maintenance periods of HVDC would represent an operational disadvantage.
315. A new and substantial strategic spares holding of HVDC equipment would probably need to be established to maintain the quoted availability.
316. For these technical reasons HVDC is not recommended over the proposed OHL connection.

## **7. CABLE SEARCH CORRIDOR TERRAIN APPRAISAL**

### **7.1 Introduction**

317. Routes for an OHL circuit have already been identified for the Project. However, the constraints for an UGC are very different to those relevant to an OHL. Thus, a strategic (high-level) assessment was made of the terrain between Woodland and Turleenan via the Kingscourt area, to establish whether there is a continuous corridor within which an underground transmission connection between these three locations would be technically feasible and likely to be environmentally acceptable.
318. This quest for a strategic search corridor is the first step in a three stage process to establish the eventual location of any cable. The second and third stages for establishing the eventual location of any cable, namely the detailed routeing and final alignment processes, are beyond the scope of this report.
319. The identification of a viable search corridor is part of a planning investigation. Completion of this stage of the process does not however mean that further steps towards an underground solution would necessarily be taken.

### **7.2 Methodology**

320. The general approach was for a PB Power team comprising transmission and landscape consultants to visit the terrain through which an underground connection would need to pass, and establish a route search corridor within which an UGC route could later be found if required. For each section of the route the team was accompanied by an environmental specialist familiar with the area.
321. The landscapes were assessed from the road with a view to choosing a corridor that would minimise impact on visual amenity and landscape and cultural heritage and archaeological features, whilst at the same time achieving the shortest technically practicable route. A later visit to specific examples of the various landscape patterns (particularly to sections of the corridor containing significant constraints) was then made by a cable installation specialist and civil works estimator (both also members of the PB Power team for this report) in order to confirm viability of those corridor sections and to establish robust, current cost estimates.

#### **7.2.1 First Visit**

322. Constraints reports and maps of the area were obtained prior to the visit.
323. Transmission and landscape consultants from PB Power attended a general briefing meeting with EirGrid and with the environmental consultants responsible for the constraints reports and maps for the sections of the transmission connection in the Republic of Ireland – that is, working south to north, Co. Meath to Co. Cavan, and on through C. Monaghan to the border with Northern Ireland. A similar meeting was held with Northern Ireland Electricity (NIE) and their environmental consultant for the section through Co. Armagh and on to Co. Tyrone.

324. A visit was made to a sample road-crossing of a gas pipeline near its crossing of the River Boyne at Drogheda, to examine its effects on agricultural areas. This 30 inch 60 bar pipeline had been laid in 2005, and had required a working swathe of approximately 30m. It was found that reinstated hedges were still thin and very evident against their new fence railings. Road patches were visible but unremarkable, whilst tilled ground to either side of the road crossing showed no evidence of the pipeline passing beneath it.
325. Straight lines were drawn on a 1:400,000 map between Woodland and Kingscourt and between Kingscourt and Turleenan – see Figure 7-13. These represented the shortest theoretical UGC route, and thus the starting point for developing a strategic cable route search corridor. A “desktop” application of UGC routing criteria to these lines, in consultation with the relevant environmental specialist, resulted in a tentative strategic search corridor which deviated from the straight lines as a result of anticipated environmental or technical considerations.
326. A driving route was then selected to allow inspection of the area through which the corridor was likely to pass (sometimes referred to here as a “windscreen survey”). During the visits photographs were taken and the corridor discussed with the environmental consultant. Notes of the visit to each section of the corridor were prepared and circulated each night for comment, and the strategic search corridor location was subsequently finalised.
327. Note: The routing criteria used to establish the strategic search corridor were developed from the team’s previous UGC routing experience, from information contained by the constraints reports and maps, and from general knowledge of the landscape character. They are discussed in Section 7.3.
328. The conclusion of the visits was that a viable strategic UGC route search corridor could be found between Woodland and Kingscourt in the south and on up to Turleenan in the north.

### **7.2.2 Second Visit**

329. A 1:50,000 map was marked up with the strategic search corridor proposed during the first visit, and this was issued to the cable installation specialist and civil estimator prior to their own site visit.
330. During the two days of site inspection, 64 individual locations were visited, noted and photographic information collected.
331. The object of the visit was to:
- view the route corridor and alternatives as selected and marked on maps by PB Power and identify any which may not be traversed by an underground cable installation and if necessary identify an alternative corridor.
  - visit and visually assess each of the terrain types / landscape patterns through which the cable search corridor would pass (a list of landscape patterns is

provided in Table 7-1) and comment upon any significant adverse implications to the use of underground cables.

- provide an opportunity for an inspection of the terrain by RPS Group<sup>[25]</sup> to determine any implication to the civil works activity both in terms of feasibility and cost.

332. From this visit observations were recorded and cost estimates for the cable installation were subsequently developed.

### **7.2.3 Refinement of Landscape Type Assessment**

333. Following the first visit, the environmental consultants for the three sections were requested to provide aerial photographs, constraints plans and landscape character plans.

334. All the supplied information was then used to check the Landscape Pattern assessment. Two additional sub-patterns were identified.

335. No part of the proposed corridor was ruled out on a technical basis by the cable installation specialist or civil estimator.

336. This background, and the comments provided by the three environmental consultants, led to finalisation of the strategic search corridor from Woodland to Turleenan. The results are presented in map and aerial photograph form in Drawings 3IE19033 /4 /6 and /7 - 18 sheets in total - Appendix 8.

## **7.3 Strategic Cable Routeing**

### **7.3.1 Objective**

337. The objective of the UGC route selection was to facilitate the design, construction and operation of circuits in a manner that is:

- Technically feasible;
- Economically viable;
- While causing, on balance, the least disturbance during construction and operation to the environment, to the people who live and work in the area, and to the people who recreate in, and visit the area (in that order of priority).

338. These same criteria were originally used in developing proposed routes for the OHL.

---

<sup>25</sup> RPS Group Consulting Engineers were instrumental in the installation of the N-S gas pipeline, and have detailed local knowledge of the issues involved in linear excavations of the type required for an underground cable.

### 7.3.2 Strategic Cable Routeing Criteria

339. The initial UGC Strategic Routeing Criteria that were brought to this work from previous routeing experience were reviewed, tested and refined during the examination of the OHL Constraints data and reports, through discussion, and during the site visits.

340. The Strategic Routeing Criteria were as follows:

**Seek** (in priority order):-

- Agricultural areas
- Areas that are regularly disturbed for other reasons
- Areas that have been disturbed recently

**Ruled out:-**

- Along rural roads

**Avoid if possible:-**

- Areas of environmental designation in which UGC construction, operation or decommissioning might affect the purpose of designation,
- Areas occupied by protected species,
- Hilltops,
- Long steep slopes,
- Ravines,
- Areas of landslip / movement / subsidence,
- Peat areas,
- Wet areas, or water bodies, or combination of these which, when considered together as an interconnected group, form a larger single constraint area,
- Areas of flooding,
- Rocky areas. Where rock outcrops appear to be grouped together, surficial geology maps should be consulted to establish the extent of the area to be avoided,
- Non-agricultural areas,
- Agricultural areas that are also designated areas or buffer zones to designated areas,
- Wooded areas, and areas of commercial forestry, wherever possible. Where these are unavoidable, avoid significant affect on the skyline,
- Areas of archaeological sensitivity, and graveyards,

- Areas of architectural importance (including associated surroundings),
- Compact settlements (a grouping that forms a small community, not including isolated houses or ribbon development,
- Areas of known settlement development planning, and
- Sterilising potential linear developments - roads, (disused) railways, pipelines.

### 7.3.3 Environmental Impact

341. The general environmental impacts of the use of UGC in place of OHL were considered and reported by PB Power for the Beaulieu Denny Public Inquiry held in Scotland in 2007<sup>26</sup>. PB Power's report identified potential permanent environmental impacts on:

- Land use,
- Geology and soils,
- Hydrology,
- Natural Heritage (flora and fauna),
- Landscape and visual amenity, and
- Cultural heritage and archaeology.

342. In addition to these, the reports identified various potential temporary environmental impacts relating to the period of construction. These included:

- Air quality,
- Traffic and noise,
- Recreation and community,
- Ground reinstatement,
- Decommissioning of the connection at end of life.

343. While the environmental impact topics identified above are generic, the actual environmental impact of UGC and OHL connections are specific to the route being considered. It should, however, be noted that construction of an UGC circuit affects the environment, in particular the landscape, visual amenity and natural and cultural heritage, in different ways to that of an OHL connection. The illustrative working swathes of land required for each application are shown in Figure 7-1 (a) and (b).

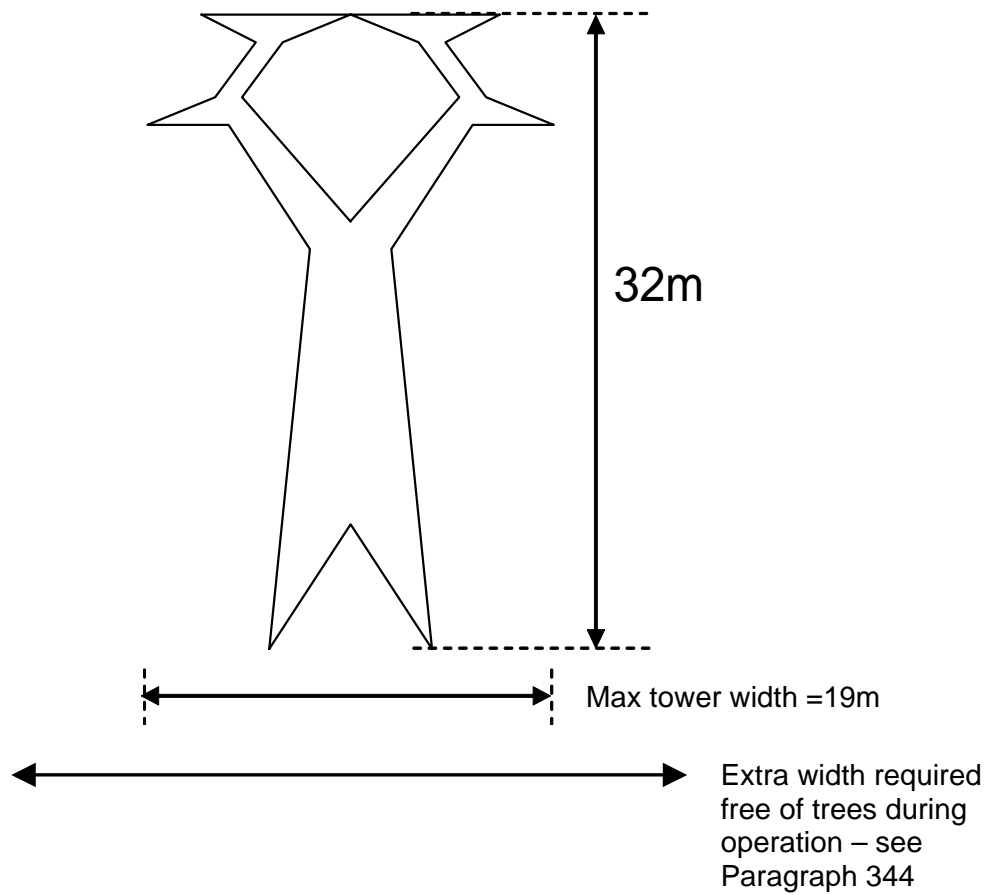
---

<sup>26</sup> Proposed Beaulieu-Denny 400kV Overhead Transmission line – the Use of Underground Cable as an alternative to Overhead Line in Specific Locations, January 2007, PB Power

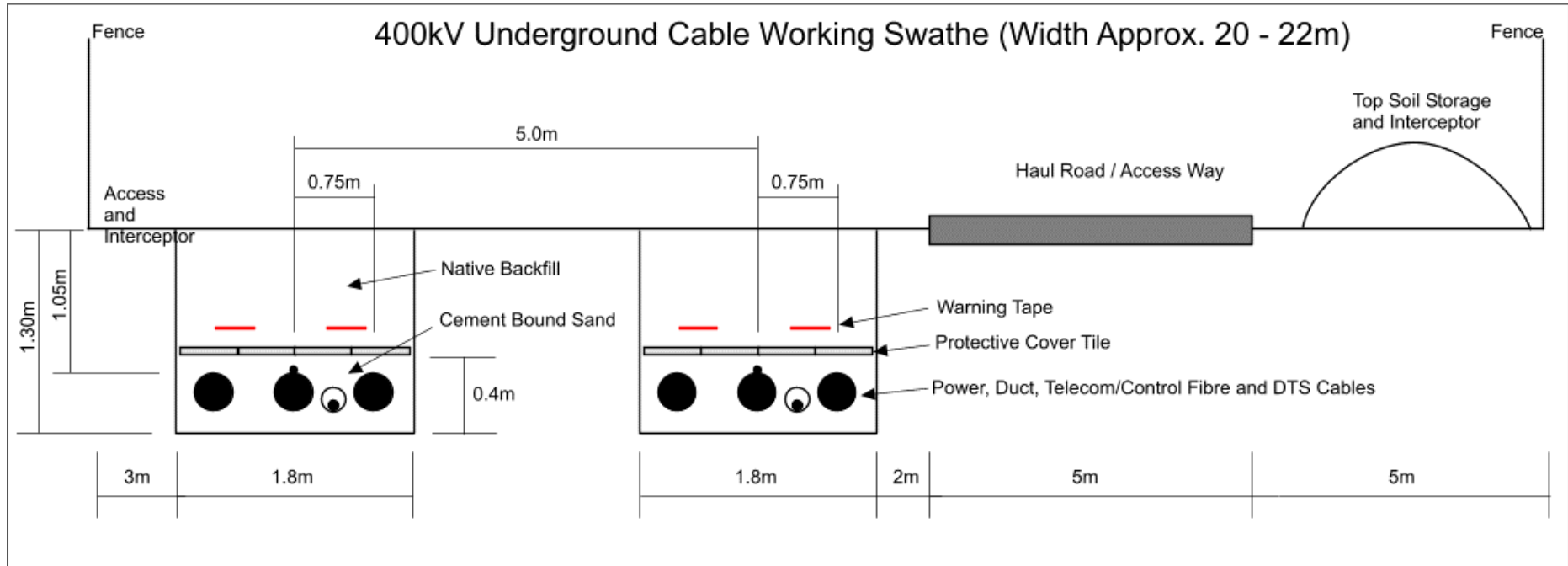


Figure 7-1 - Comparison of working swathe of overhead line and UGC

(a) 400kV single circuit OHL swathe (not to scale)



**(b) 400kV single circuit, two trench, UGC working swathe**



344. It should be noted that, in operation, both OHL and UGC would require a swathe to be kept permanently clear of trees. For the UGC this swathe would be to obviate cable damage due to root growth. For the OHL the swathe would protect the OHL from falling trees. The Energy Networks Association<sup>[27]</sup> provides additional guidance on the relationship between tree height, conductor ground clearance and separation distance between tree and OHL route centre-line.
345. From the first PB Power site visit and from other previous experience of UGC routeing, examination of the Project OHL constraints data, and discussion, the following hypotheses were formulated (and later confirmed during the site visits):
- A strategic UGC route would run across (as opposed to running in parallel with) the main river, road and settlement patterns in the landscape;
  - It would be easier to route in agricultural areas where the buildings are dispersed than in areas where buildings are concentrated along roads or form small groups
  - Rural roads are generally limited in width, often with tight bends, and of a character that would be lost if construction traffic required major alterations to width and bends.
346. Considering the impact upon the environment and upon local traffic, these three factors would inevitably lead to the construction of a temporary access haul road system along the length of the UGC route. This haul road would be connected to highways of an appropriate standard to allow movement of large quantities of trenching spoil, construction materials and cable drums. Haul road and construction swathe are mentioned further in Section 3.5 of this report.
347. Agricultural ground is the first choice of terrain for Underground cable laying since it is likely to have a disturbed subsurface as a result of ploughing and drainage and is likely to be cropped or grazed. Subsurface archaeology is likely to have been disturbed and reinstatement of this type of groundcover is more likely to be effective in both short and long term than the reinstatement of semi-natural or natural ground cover where, in the longer term, the effects of construction and heat emission from the cables on the reinstated ground cover can lead to changes in the semi-natural or natural groundcover in the immediate vicinity of the cables.

#### **7.3.4 Other General Observations**

348. It is usually less expensive to grub out hedges and to remove and replace walls and fences than to cross under such structures using trenchless techniques and diverting the haul road through an existing gap elsewhere. This approach may, however, have an impact upon the Project schedule since there are times of the year when bird nesting would preclude such activity.

---

<sup>27</sup> Energy Networks Association Technical Specification 43-8, Issue 3, 2004, Overhead Line Clearances.

349. The hedge, fence and walls bordering the fields would, however, provide good positions for joint bay and link equipment as they may be positioned close to the field boundary and thus, generally, be less susceptible to damage from farm machinery.
350. Installing the cable system within the root boundary of large growing tree species is best avoided as a precaution against cable root damage.
351. Top soil preservation and reinstatement would also be likely to be required at most locations along the route and the exchange of soils between fields should be avoided as a precaution against possible soil cross contamination and subsequent land owner or tenant compensation events.
352. Any damage to field drains during excavation would require repair. Drainage and sediment issues may also require the installation of interceptor drains and settlement ponds along the route to avoid sediment contamination of water courses.
353. A cost allowance would need to be made for any delay as a result of the discovery and subsequent investigation of archaeological remains.
354. For the route corridors under investigation there are a significant number of small water courses to be crossed by both the cable system and the haul road. It would therefore be necessary to install a number of crossing points for both the haul road and cable route that would remain as permanent installations for the life of the cable system allowing maintenance access.
355. Access to most of the corridors is poor for heavy traffic; such as cable drum carrying lorries. In general the lowest grade of road suitable for carrying cable drum lorries are the Regional Roads ('R' roads in the Republic of Ireland and 'B' roads in Northern Ireland). Only very short sections of the cable corridors contain 'R' roads running along the corridor in the same direction. It is therefore most likely that haul roads would be required along the entire cable route, with site access points arranged at intersections between the cable swathe and a suitable regional or National Road ('N' road in the Republic of Ireland and 'A' roads in Northern Ireland).
356. The cable route corridors do not include any significant route lengths where installation of underground cables along the surface of a road would be required. Installation of cables beneath roads would therefore only occur at road crossing points.
357. The terrain types generally offer adequate room to accommodate a cable working swathe required for the installation process, provided that field boundary walls and hedges at swathe crossing points may be removed and subsequently replaced.
358. Provided that the UGC river crossings may be performed using ducts installed by directional drilling, no areas visited indicated a need for a tunnelling solution.
359. The installation of XLPE insulated cables and joints in surface trough, or suspended in air, is not suitable for use in land that is open to the public or that is subject to ploughing without additional mechanical protection. Such mechanical protection

would be cost prohibitive compared to direct burial. The minimum depth of burial to the cable warning cover tile to avoid ploughing is around 900mm.

## 7.4 Landscape Patterns

### 7.4.1 Introduction

360. Regarding the impact of an UGC on the landscape, the key considerations in identifying a strategic route corridor were;

- Routeing constraints relating to natural and cultural Heritage, landscape value and features,
- The use of agricultural land given its existing subsurface disturbance and the relative ease of reinstatement, and
- Topography – access difficulties caused by, and alternative views afforded by, the slope.

361. In conjunction with the technical feasibility, these considerations both individually and in combination influence the choice of UGC route search corridor and therefore Project cost.

### 7.4.2 Landscape Pattern Descriptions

362. To assist with the choice of UGC route search corridor and costing, the landscape was categorised into patterns during the site visit

. Table 7-1 lists these, along with two sub-categories (2ab and 2bb) that were subsequently identified from the aerial photographs:

**Table 7-1 – List of Landscape Patterns**

<b>Landscape Pattern</b>	<b>Characteristics</b>	<b>Implications for UGC</b>
1	Flat agricultural land	Long straight sections of UGC in an area of predominantly large fields.
2	Drumlin, with few constraints	Long straight sections of UGC, on hill side-slopes in an area of predominantly small fields.
2 a	Drumlin with few constraints	Shorter sections of UGC including hill side-slopes and frequently crossing streams in an area of mixed field sizes.
2 aa	Drumlin with few constraints	Mainly straight sections of UGC on gentle slopes, but with small constraints such as tree groups and individual trees to negotiate in an area of predominantly large fields.

Landscape Pattern	Characteristics	Implications for UGC
2 ab	Drumlin with constraints	Shorter sections of UGC including hill side-slopes and frequently crossing streams in an area of predominantly small fields.
2 b	Drumlin with significant constraints	Shorter sections of UGC crossing slopes and frequently crossing streams, and also winding around significant constraints in an area of mixed field sizes in a predominantly irregular pattern
2bb	Drumlin with significant constraints	Shorter sections of UGC crossing slopes and frequently crossing streams, and also winding around significant constraints in an area of mixed field sizes in a predominantly regular geometric pattern.
RC	River Crossing: Wide main river	Cross river avoiding steep banks where possible

**Figure 7-2 - Two examples of Landscape Pattern 1 – Flat Agricultural Land**



**Figure 7-3 - Landscape Pattern 2 – Drumlin Valley**



**Figure 7-4 - Landscape Pattern 2a – Drumlin with Hill Slopes**



**Figure 7-5 - Landscape Pattern 2aa – Drumlin with Few Constraints**



**Figure 7-6 - Landscape Pattern 2b – Drumlin with Significant Constraints**



**Figure 7-7 - Landscape Pattern RC – Wide River Crossing**



### 7.4.3 Examples of Routeing Constraints

**Figure 7-8 - Lakes**



**Figure 7-9 - Wet areas**



**Figure 7-10 - Areas of flooding and other features such as groups of houses and trees**



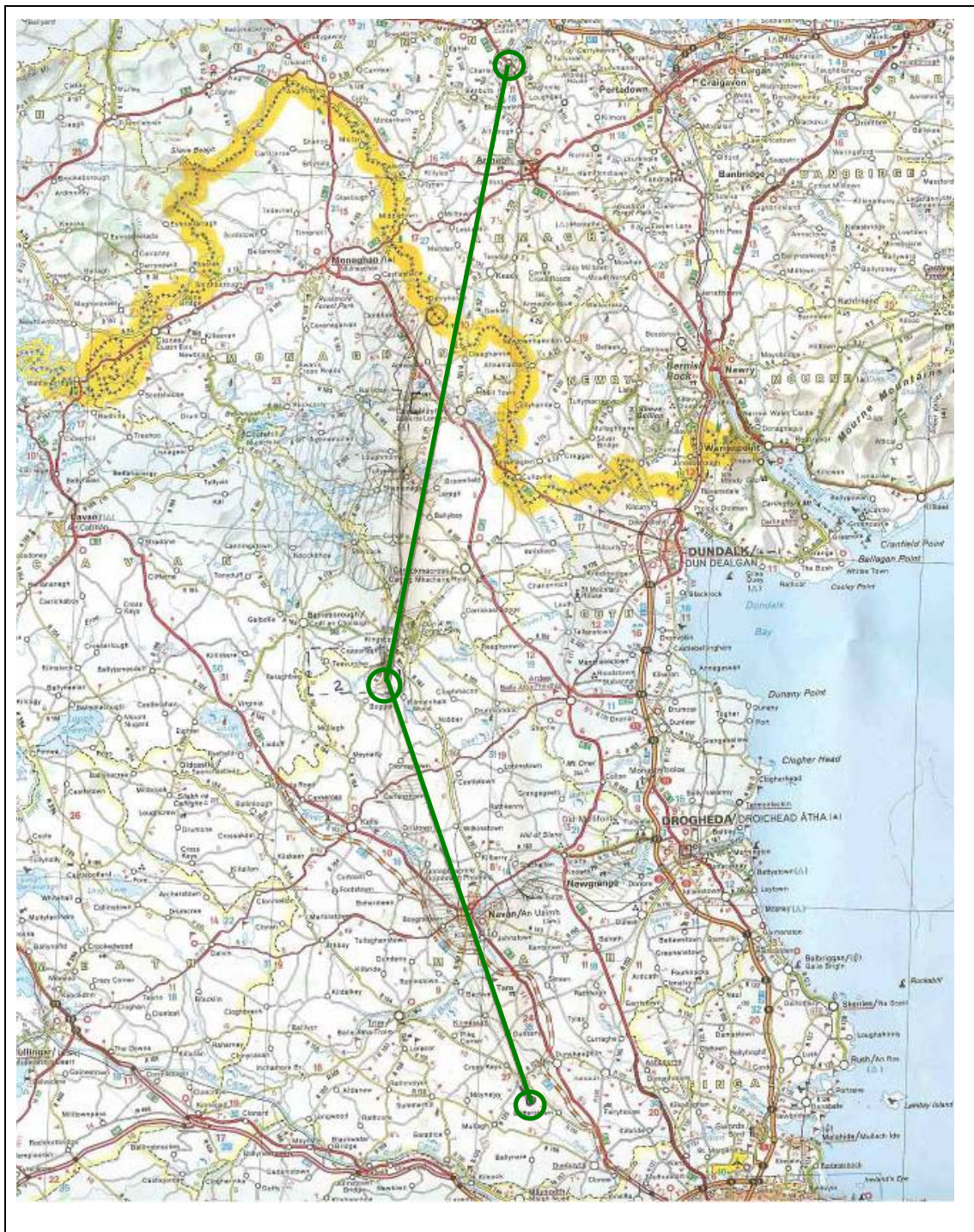


**Figure 7-11 - Steep slopes****Figure 7-12 - Drumlin top, trees, valley with trees**

## **7.5 The UGC Strategic Search Corridor**

363. This section presents the straight-line starting position in the search for a strategic routing corridor, and then offers examples of the maps and aerial photographs that have been used to develop the corridor. The final strategic search corridor is presented on a series of maps in Appendix 8. It runs from Woodland Substation in Co. Meath northwards through Co. Cavan, Co. Monaghan and Co. Armagh and finally into Co. Tyrone.

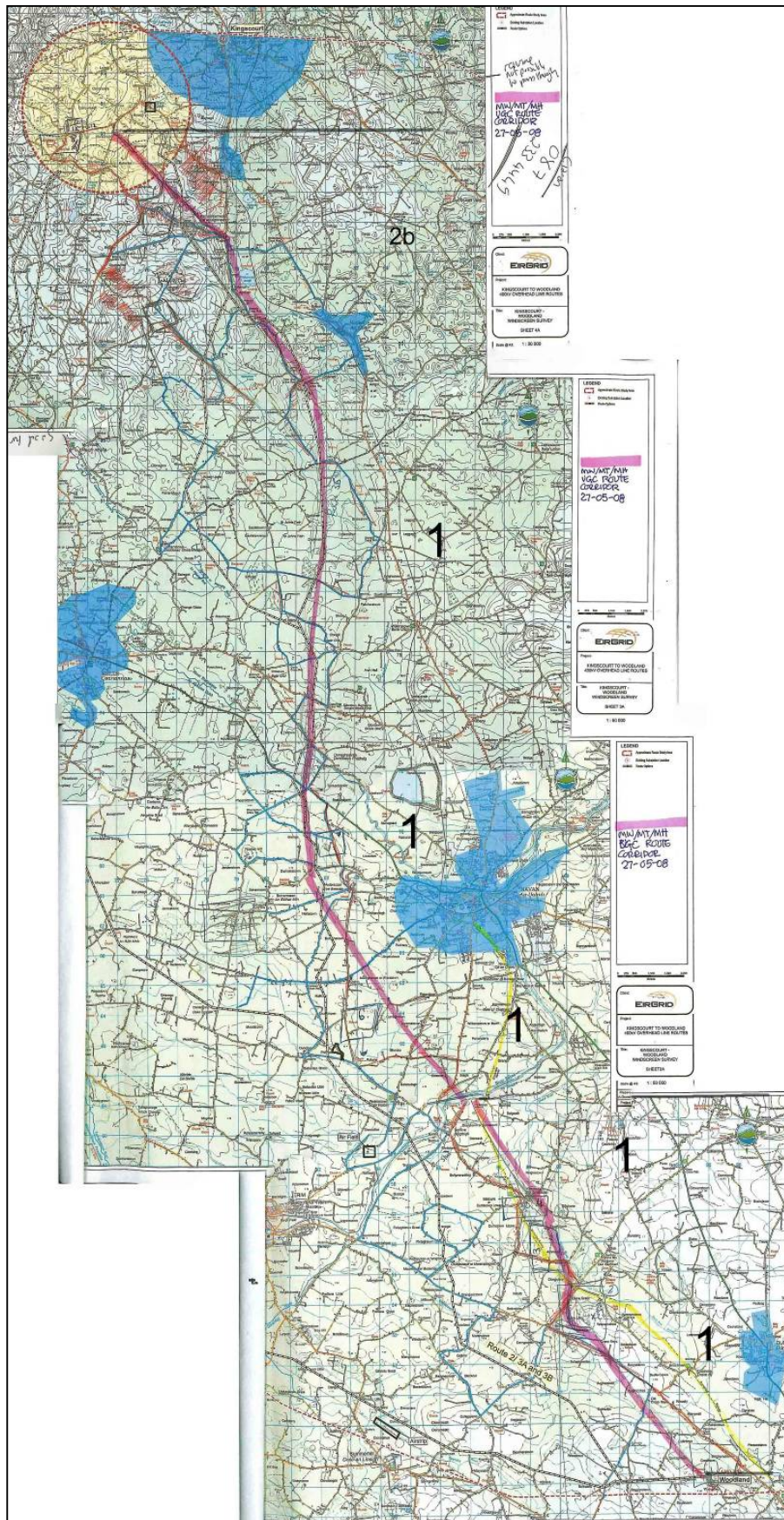
Figure 7-13 – Straight Line Starting Position



### 7.5.1 Woodland to Kingscourt

364. No aerial photograph was available at the time of the visit by the transmission and landscape consultants from PB Power, however, a detailed constraints map, a commercial and residential buildings map (with planning applications), and several OS maps of the area were available. These documents are available elsewhere and are not reproduced here.
365. Figure 7-14 depicts the initial strategic UGC route search corridor that was proposed following a windscreen survey. The final version of the corridor is provided in greater detail in Appendix 8 - Maps and Drawings.
366. Towards the northern end of this section of the corridor the Drumlin terrain becomes quite challenging for cable routeing, and an alternative corridor was identified in case the first selection proved to be technically impractical.

Figure 7-14 – Strategic UGC Corridor and Landscape Patterns – Co. Meath



### 7.5.2 Kingscourt to The Border

367. A large scale paper aerial photograph was available at the time of the visit by the transmission and landscape consultants from PB Power, as were a Landscape Sensitivities map and several OS maps of the area. These documents are not all reproduced here, however Figure 7-15 shows the constraints map with the initially proposed UGC route search corridor.
368. Figure 7-16 depicts the initial strategic UGC route search corridor that was proposed following a windscreen survey. The final version of the corridor is provided in greater detail in Appendix 8 - Maps and Drawings.
369. Towards the northern end of this section of the corridor the terrain becomes quite boggy with a number of areas of rocky outcrops. Two alternative corridors were thus identified in case the first selection proved to be technically impractical.

Figure 7-15 - UGC Routing Constraints, Landscape Character Types – Co. Cavan

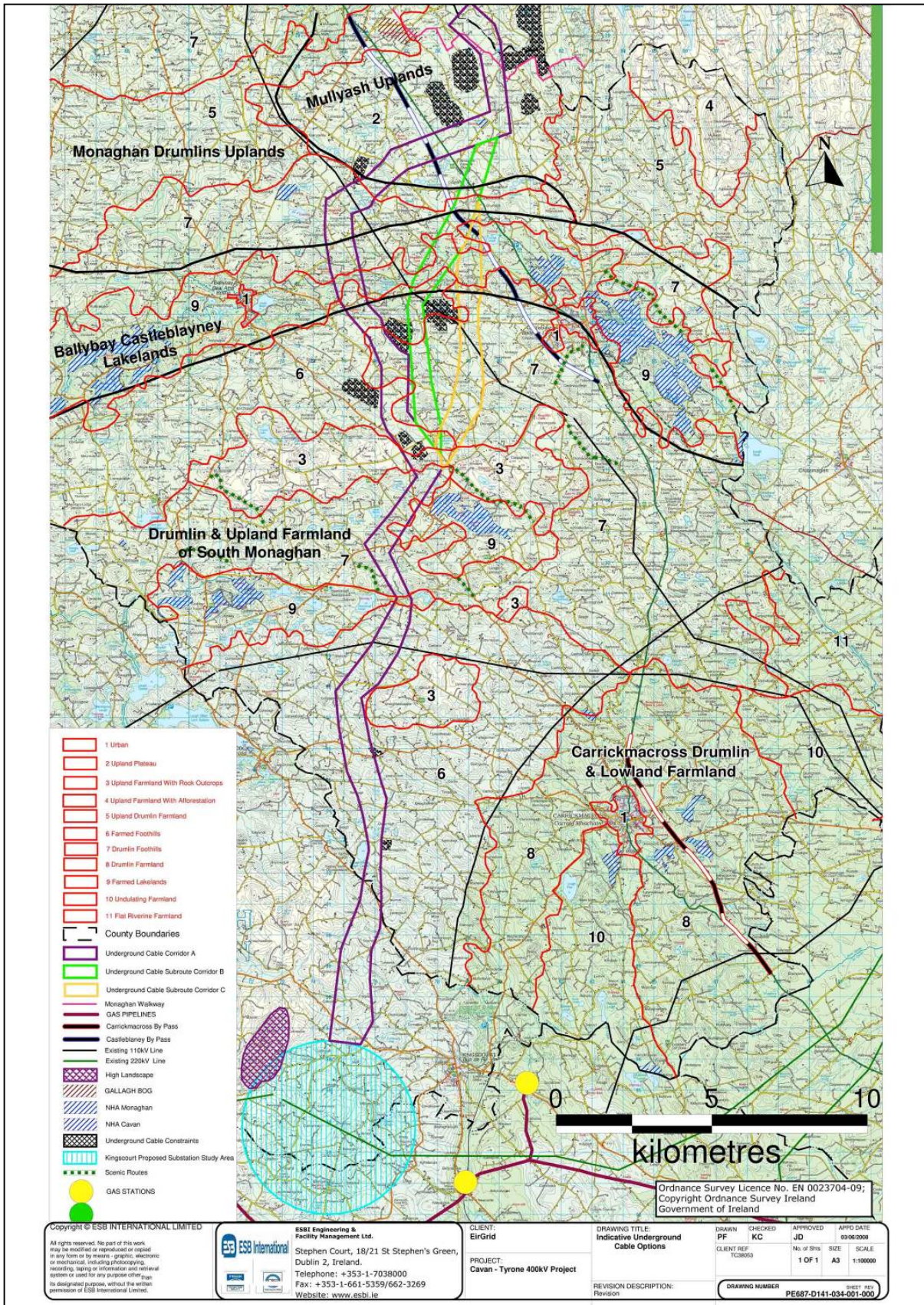
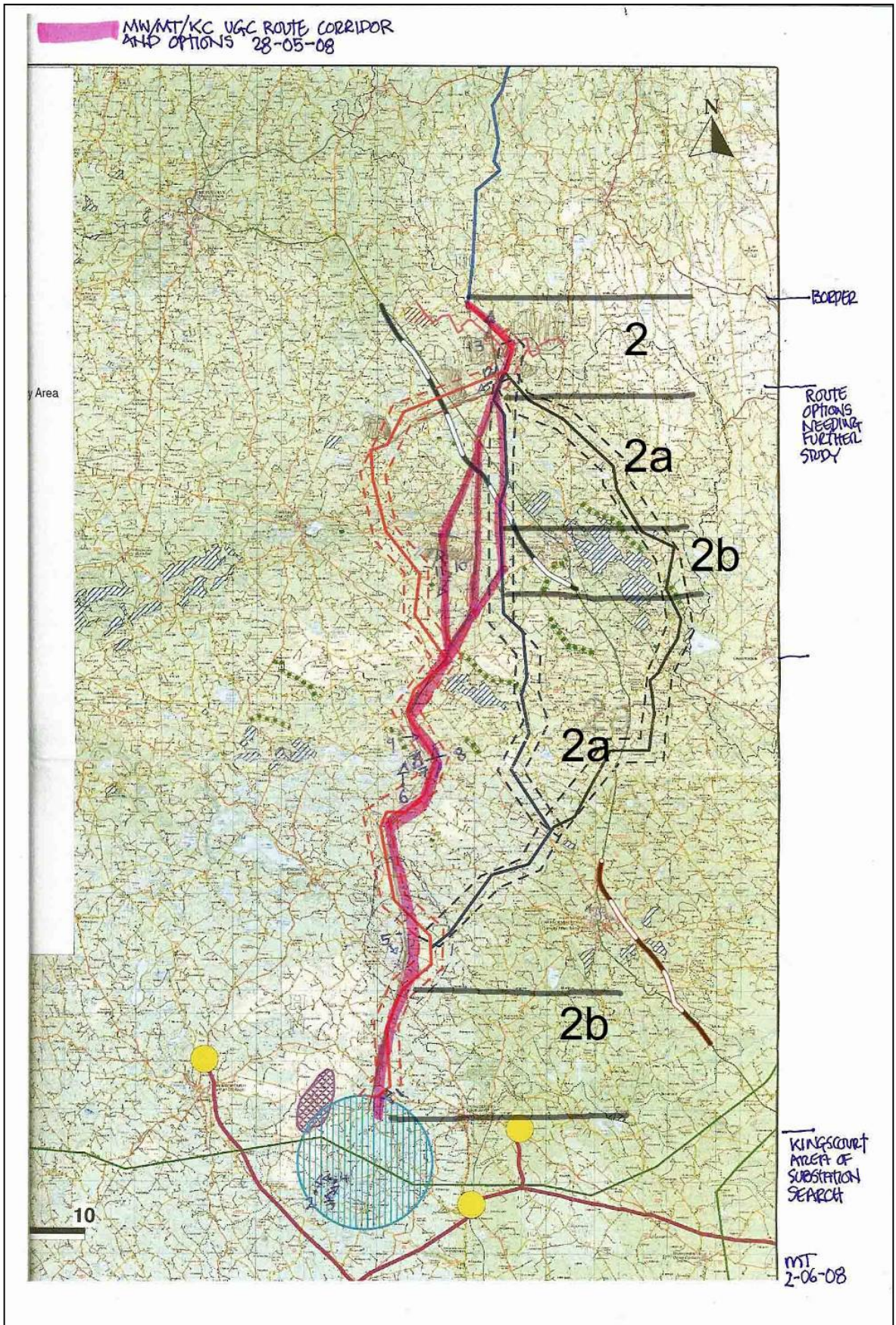


Figure 7-16 – Strategic UGC Corridor and Landscape Patterns – Co. Cavan



**The Border to Turleenan**

370. No aerial photograph was available at the time of the visit by the transmission and landscape consultants from PB Power to this section of the route, however a Landscape Sensitivities map and several OS maps of the area were available. Figure 7-17 shows the constraints map that was also available at that time.
371. Figure 7-18 depicts the initial strategic UGC route search corridor that was proposed following a windscreen survey. The final version of the corridor is provided in greater detail in Appendix 8 - Maps and Drawings.



Figure 7-17 - UGC Routeing Constraints, Landscape Character Types – Armagh

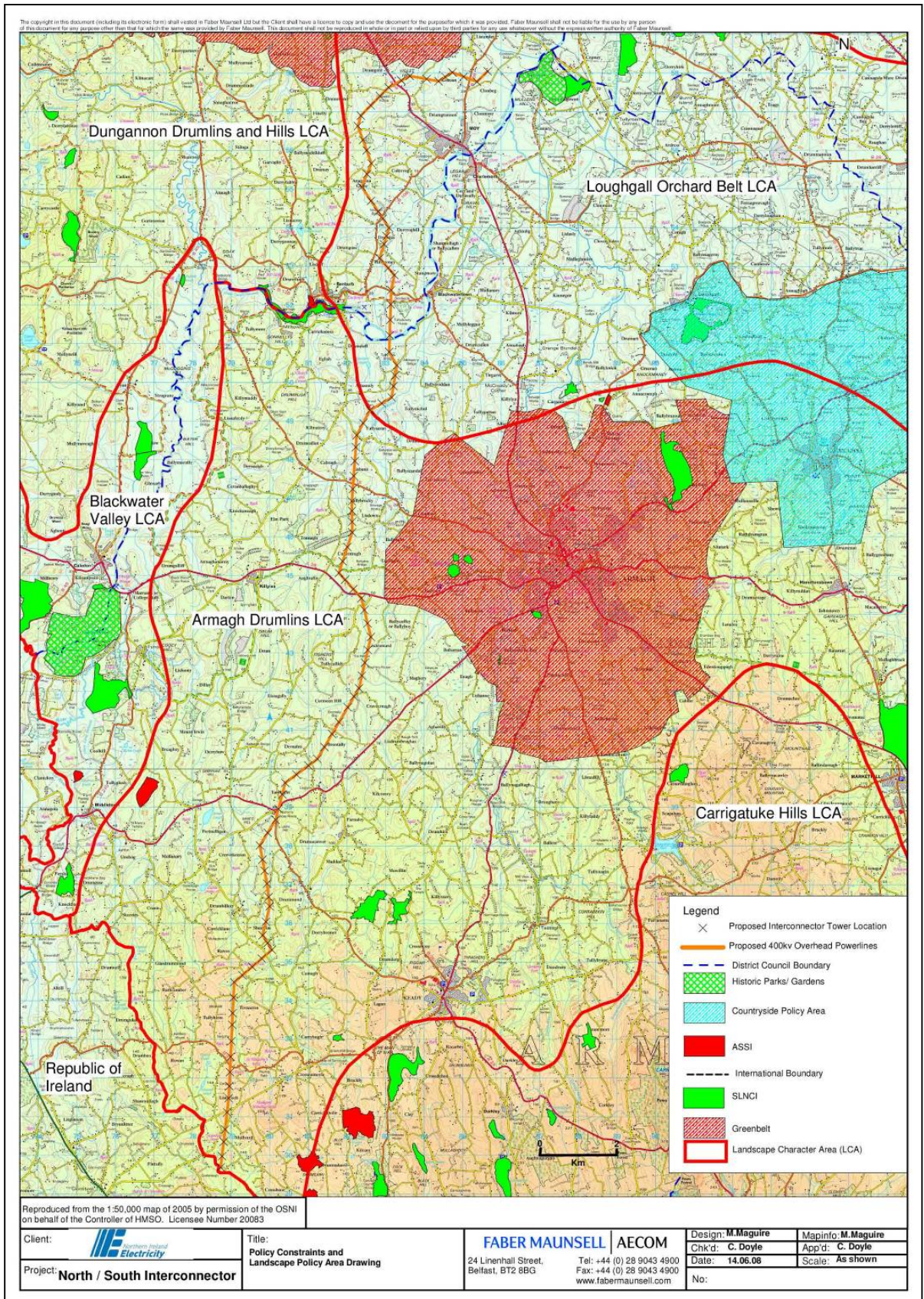
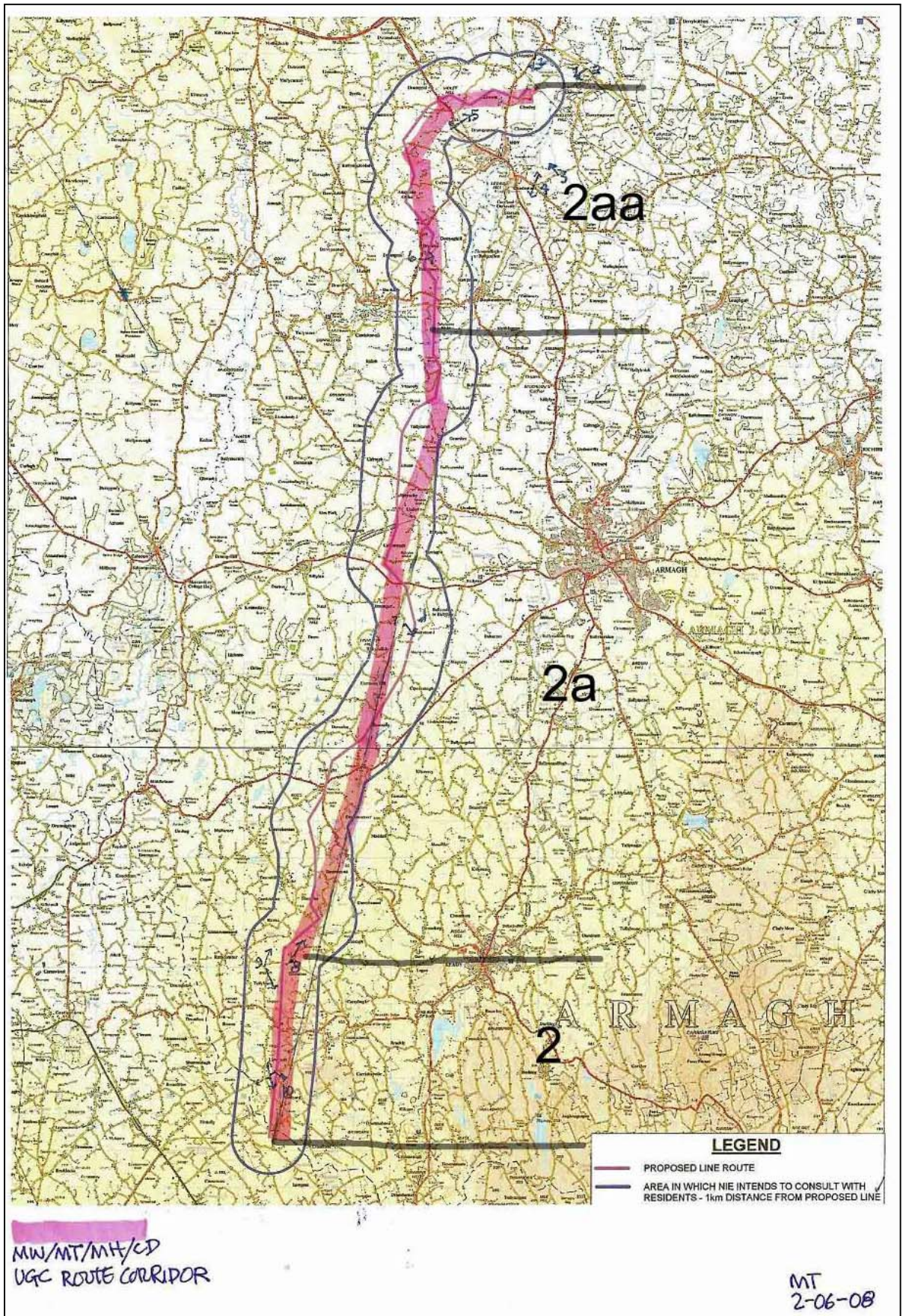


Figure 7-18 – Strategic UGC Corridor and Landscape Patterns – Armagh



## **7.6 Conclusions on the Strategic UGC Search Corridor**

372. Routeing criteria for establishing UGC strategic routeing corridors have been developed to accommodate the landscape characteristics of the terrain over the whole route.
373. A continuous, technically feasible, strategic UGC route search corridor for the Project that satisfied these routeing criteria has been identified.
374. The search corridor passes principally through agricultural land, and avoids routeing constraints presented by identified natural, cultural heritage, and landscape features. Though Landscape Type 2b presents probably the most challenging of the terrain types, even these areas are not prohibitive to the installation of UGC using the direct-buried technique.
375. The identified underground cable route search corridor avoids crossing any area “designated” for landscape purposes.
376. Landscape patterns were found to be a useful approach to managing routeing considerations, assessing UGC route options and estimating drum lengths, and thus estimating civil and overall undergrounding costs.

## 8. CONSTRUCTION AND LIFETIME RUNNING COST COMPARISONS

377. The estimates included in this document are, wherever possible, based upon current supplier estimates and known costs for previous actual projects indexed to present day values.
378. That said, these estimates are necessarily subject to changes in the prices prevailing in international markets. The world energy market has seen a run of high prices (compared to historic levels) recently, as well as significant rises in the prices of commodities, particularly metals. Whilst there has been a recent drop in prices the price of both energy and metals are above historical levels even given the fears of a World recession. Worries about depression, coupled with a total loss of liquidity in the financial markets, has led to a sustained decrease in central bank lending rates to historically minimum levels, nevertheless tightness in money markets has led to an increasing difference between central bank rates and commercial lending rates, with the inherent impact on project financing costs.
379. There has been much debate about the levels of price rises due to speculative influences compared to the longer term underlying trends in prices being driven by higher levels of demand, especially from Asian countries. Following the expected rise in economic activity in 2010 such speculation, or other influences, may once again cause fluctuations. Thus, whilst the estimates in this document are “best present estimates”, there is an inherent uncertainty in them that is being driven by uncertainty of global price trends. For this reason the cost estimates should be treated with care; future estimates and any final prices could be higher or lower depending on international trends.
380. Although the technologies employed are different, there are similarities in the raw materials used in each option presented here. For this reason, although the budget estimates contain uncertainty, we would expect this uncertainty to be lower when a comparison is made between the options. Therefore, we believe, that this document does offer a fair basis for comparison of technology alternatives, even given the global volatility in prices and price expectations.
381. Whilst this document does not consider the benefits of the proposed Project, but only the costs, it should also be noted that the full benefits of the proposal would be obtained only if the whole Project – both circuits – were to proceed together and if the technical issues were considered as a cohesive whole.
382. The intention of these cost estimates is to allow considered comparison between the costs associated with overhead lines (OHL) and underground cables (UGC) and between HVAC and HVDC. As will be seen in the following tables, the cost estimates are developed, so far as possible, on a “bottom-up” basis – that is, by identifying the costs of the construction project components and then summing them to arrive at an overall cost estimate. In particular the costs associated with the underground option are site-specific.

383. The cost estimates are all quoted at 2008 values. Where appropriate, the BEAMA CPA/1 Basic Electrical Equipment Index <sup>[28]</sup> has been used to adjust prices from earlier projects.
384. Forecasting the absolute costs at the time that construction contracts are to be let is beyond the scope of this report. Furthermore, although some of the tables that follow make reference to the costs associated with land access management and land owner compensation, estimating these components is beyond the scope of this report.

## 8.1 Discounted Cash Flow (DCF)

385. Although there is no attempt here to forecast future prices, discounted cash flow analysis (DCF) has been used to bring expected future cash flows back to today's equivalent values. All the transmission equipment discussed here is assumed to have a 40 year life, either as a natural outcome of its design or as a result of planned (and possibly extensive) maintenance and refurbishment periodically to ensure that reliability and availability during its 40 year nominal life remains at an acceptable operational level. For this reason all the DCF analyses consider a 40 year period and conclude with a notional cost to decommission the aged equipment and replace it on a like-for-like basis.
386. For the DCF analysis, a 7.6% discount rate has been selected. This is a typical value for this kind of assessment, but of course, in practice, values for WACC will change as the companies adjust their finances and as the economic situation varies. Another reason for choosing this figure is that it happens to be the average of the real, pre-tax weighted average cost of capital (WACC) for other electrical power plant estimated for Northern Ireland and the Republic of Ireland in Table 4, page 20, of the AIP Consultative Document 4 July 2008 <sup>[29]</sup>.
387. A simplified form of Interest during construction (IDC) has been applied in the calculations. Whilst recognising that practical execution of either an OHL or an UGC project could take several years, the working assumption here, for ease of comparison of the alternatives, is that the construction would take two years. Thus, the capital cost of the project has been split evenly across the first two years of the discounted cash flow analysis. In year 1, IDC is calculated as half the capital spent times the discount rate. In year two the discount rate is again applied to half the capital spent in that year, but also to the entirety of the capital spent the previous year.

## 8.2 Estimates, Uncertainty, and Contingency

388. Cost estimates for the construction of a new circuit are subject to many types of uncertainty and, insofar as they affect the project cost they are often classified into

---

<sup>28</sup> CPA/1 – Basic Electrical Equipment Index, from the BEAMA Price Index of Materials used in the Basic Electrical Equipment Industry

<sup>29</sup> The All Island project (AIP) Single Electricity Market Fixed cost of a Best New Entrant Peaking Plant for the Calendar Year 2009 – Consultation Paper 4 July 2008 – AIP/SEM/08/083

“physical” and “price” uncertainty. This section briefly identifies some of the factors involved, since it is important to bear these in mind when considering the cost estimates that follow.

389. The physical factors that can affect the costs of a project relate to changes in quantities, methods of working, or period of implementation, and might include:
- Civil engineering / geological uncertainties,
  - Inaccuracies in quantity estimation,
  - Manufacture and transport problems,
  - Weather (for site installation work),
  - Other delays to the project that may or may not be controllable by the supplier, and
  - Metal exchange prices (copper, aluminium, zinc, lead).
390. The price factors that can bear upon the cost of a project are not all independent of each other, and include:
- Changes to estimates in unit prices,
  - Current market conditions (how busy are the suppliers, availability of materials),
  - Contract conditions and the flexibility to vary the price after the contract has been signed, and
  - International exchange rates <sup>[30]</sup>.
391. As the time for a project's execution comes closer it is often possible to reduce many of these risks by site surveys, geological surveys, agreeing price contracts, and even by consulting the weather forecast where the weather is a material factor to the success of the operation. Before this time, however, a contingency cost is normally added to the estimate to take account of unidentified but likely costs. It is assumed that only some of the unknown or unidentified costs will materialise. The contingency level is sometimes the subject of Company policy, but in practice should reflect the risk (likelihood and impact) of unidentified costs materialising later. Contingency costs have thus been added to the Project “best estimates”. The two main contingency rates used in this report are discussed next, and their application to the estimates are identified separately in the tables for clarity.

---

<sup>30</sup> Various tables that follow make reference to a Pound Sterling / Euro exchange rate of around £1 = €1.25 . This was the rate that pertained at the time the majority of the cost estimates in this study were assembled. At the time of publication of this report the Sterling / Euro exchange rate is very volatile, and has moved towards 1:1. No attempt has been made to follow this rate in the report, however some sensitivities to this rate are reported at the end of this Costs Chapter.

392. Whilst weather, exchange rates, and many other factors could affect the pricing of this new connection, the biggest single physical uncertainty when considering undergrounding the connection is seen to be the workability of the terrain (steep in some places) and the geology (rock in some places, soft ground cover in others). These unknowns impact much more heavily on the UGC solution than on the OHL for two reasons:
- Whilst the UGC has to pass right through the rock or soft ground in its path (or suffer a possibly lengthy and thus costly diversion), the OHL tower locations may be chosen with a considerable degree of flexibility, allowing the circuit to oversail difficult stretches of terrain without difficulty.
  - The cable trenching contractor needs to operate on every single part of the route, and where access becomes difficult due to the steepness (or other characteristic) of the land, installation costs can escalate in unexpected ways.
393. The variations in the geological conditions encountered during horizontal directional drilling (HDD), and the sensitivity of the costs to these variations, introduces another major source of costing uncertainty for the underground cable alternative. Where ground is unknown and proves troublesome costs for the HDD process can rise by as much as a factor of 3. In view of this situation a conservative 30% “geological uncertainty factor” has been applied to the moderate base estimate for these costs. Whilst the site visits for this study assessed the landscape, no detailed ground borehole survey was carried out.
394. Another uncertainty factor in the comparison between OHL and UGC relates to the movement of the prices of copper, aluminium, zinc (for galvanising) and lead. Prices for all these metals are published by the London Metal Exchange, and in fact steel billet is also discussed there. However a point to note, in particular if comparing the published cost of raw steel billet with the final cost of steel for overhead line towers, is that the latter will be much higher per tonne because of the degree of “manufacture” required before it can be delivered to site. World prices for metals have seen unusual rates of increase in recent years, and are subject to significant fluctuation.
395. For these reasons, for both OHL and for UGC, this report has assumed a 15% contingency factor for all work below ground level, and a 10% factor for other costs.

### 8.3 HVAC OHL costs

396. There are a number of factors to be considered in the development of useable transmission circuit price estimates. Amongst these the prices of steel, zinc and aluminium are particularly significant. As the introduction to this report notes, all have risen sharply over recent years. This document does not purport to forecast future Project costs, however it is perhaps worth recognizing that, despite the recent precedent of rising prices, the World Bank<sup>31</sup> is presently forecasting that the nominal

---

<sup>31</sup> World Bank URL containing metal price forecasts:

[Hhttp://web.worldbank.org/WBSITE/EXTERNAL/EXTDEC/EXTDECPROSPECTS/EXTGBLPROSPECTSAPRIL/0,,contentMDK:20423496~isCURL:Y~menuPK:902607~pagePK:2470434~piPK:2470429~theSitePK:659149,00.html](http://web.worldbank.org/WBSITE/EXTERNAL/EXTDEC/EXTDECPROSPECTS/EXTGBLPROSPECTSAPRIL/0,,contentMDK:20423496~isCURL:Y~menuPK:902607~pagePK:2470434~piPK:2470429~theSitePK:659149,00.html)

H

prices of some metals, including aluminium and zinc will have peaked in 2008, with prices predicted to drop somewhat in the near future.

397. Regarding OHL manufacture, whilst alloys of aluminium are drawn, in a relatively continuous and straightforward process, to produce the final conductors, the hot-rolled prepared steel angle (various gauges) from which towers are constructed needs to be cut to a multitude of sizes, and then individually drilled and galvanised before delivery to site. Thus the material / manufacture cost ratio of overhead line conductor can approximate to 80/20, whilst that of the towers would lie closer to 50/50. In other words, in contrast to overhead line conductor systems, the cost basis for tower steel is significantly wider than just the raw material costs.
398. Quite separately to the issues of metal market forecasting and the variability of the link between the price of the raw materials and the final manufactured cost, however, is the variability, particularly of steel prices, across the world. European steel prices can be twice or more those to be found in the Far East, so an electricity transmission company's purchasing policy will have a very significant effect on the final price of a given project.
399. The OHL cost estimate takes a "compromise position" between European and Far Eastern raw material costs. Where prices per tonne are quoted, these are not for the raw material but for the "manufactured" product, as delivered to site.
400. There are three overall aspects to the cost estimates for overhead lines. These are:
1. Capital costs of construction including not only the equipment supply and installation but also, for example, negotiation with landowners, temporary access arrangements, and accommodation of other services,
  2. Operational costs, both maintenance and losses, capitalised to today's value, and
  3. Replacement cost in 40 years, estimated at today's value.
401. These three elements have been included in a whole-of-life discounted cash flow (DCF) analysis, and each is now considered in turn. It should be noted however that the specific costs of negotiation with landowners and temporary access arrangements are beyond the scope of this report.

### **8.3.1 HVAC OHL capital costs**

402. The purely technical aspects of building the two OHL circuits of the Project together could reasonably represent a two year construction schedule, and this period has been assumed for this cost estimate study.
403. PB Power's experience of equivalent specification OHL supply in other parts of the world has been recorded in a database of costs from which cost estimates for further projects may be built up. A list of considerations that go into such a build-up is provided in Appendix 1 - Unit Cost. Indicative unit costs for the proposed 400kV Meath – Cavan – Tyrone Project, along with suitable contingency and cost estimate range, are shown in Table 8-1:



**Table 8-1 – Unit Costs of HVAC OHL (World)**

	<u>€/ km</u>	<u>£ / km</u>	<u>% of Total</u>
Material	252,212	201,681	41%
Time (Contractor)	198,407	158,656	33%
Other costs	57,198	45,738	9%
Engineering & Project Management	45,398	36,303	7%
<b>Supply</b>	<b>553,215</b>	<b>442,377</b>	<b>91%</b>
OHL Supply Contingency @ 10% (see text)	55,322	44,238	9%
<b>Supply Total, inc. PM &amp; Contingency</b>	<b>608,537</b>	<b>486,615</b>	<b>100%</b>
Land Access Management, incl. land owner compensation (€)	<b>(Beyond scope of report)</b>		
<b>Supply Total, inc. PM &amp; Contingency</b>	<b>608,537</b>	<b>486,615</b>	<b>100%</b>
<b>PB estimate- lower</b>	<b>488,764</b>	<b>390,839</b>	<b>80%</b>
<b>PB estimate- upper</b>	<b>730,157</b>	<b>583,869</b>	<b>120%</b>

404. The “Other” costs include, amongst other things, provision for temporary access roads.
405. The “Land Access Management” costs have not been included here since they are beyond the scope of this report. In any event, it is quite possible that similar costs would be incurred whether OHL or UGC was eventually deployed. Though these costs are not included here since the aim of this study is to highlight cost differences between the alternatives, it would be important not to lose sight of these costs in the overall picture.
406. The PB unit cost estimate is based upon their extensive database of transmission line costs for projects around the world. No two projects’ unit costs would be the same, however, so Table 8-1 also shows estimates assuming a +/- 20% variation in the total supply costs.
407. This study has been carried out without absolute certainty about the routeing of the proposed OHL, and assumptions are made here about the route lengths, for each section. These assumptions are included in Table 8-2 along with the calculated cost estimates to build each section of the OHL:

**Table 8-2 – OHL Lengths and Cost Estimates**

<b>OHL Route Section Length Estimates</b>			
<b>Meath-Cavan, EirGrid (km)</b>	<b>Cavan-Tyrone, EirGrid (km)</b>	<b>Cavan-Tyrone, NIE (km)</b>	<b>Whole Route (km)</b>
52.9	44.7	30.7	128.2

NB: These distances are used to allow like-for-like comparison of OHL and UGC costs, and should not be taken to represent a particular OHL route.

<b>Overall OHL Unit cost (€/km)</b>	<b>OHL Route Section Cost Estimates</b>			
	<b>Meath-Cavan, EirGrid (€M)</b>	<b>Cavan-Tyrone, EirGrid (€M)</b>	<b>Cavan-Tyrone, NIE (€M)</b>	<b>Whole Route (€M)</b>
0.609	32.2	27.2	18.7	78.0

Source of route lengths: PB study of OS Maps, and site visits

### 8.3.2 HVAC OHL operational costs

408. OHL operations (losses) and maintenance costs have been estimated over a nominal 40 year life and have been included in the capital sums whole-of-life discounted cash flow analysis. Certain assumptions have been made regarding these quantities, as follows:-

#### 8.3.2.1 HVAC OHL - maintenance costs

409. OHL maintenance costs are estimated as a percentage of the original capital cost of the equipment based on standard industry experience – see Table 8-3 – and are considered to include regular safety patrols, brush clearance, and sundry repairs as well as tower painting at approximately 20 year intervals.

**Table 8-3 – OHL Maintenance Costs**

O&M – OHL (% of capital value pa) =	0.2%
-------------------------------------	------

#### 8.3.2.2 HVAC OHL - costs of lifetime losses

410. Energy losses have been calculated by assuming a power flow of 500 MVA (as advised by NIE and EirGrid) and by using a short run marginal cost (SRMC) of generation - i.e. fuel cost - of €0.04/kWh. This figure has been derived from page 28 of AIP consultation paper AIP/SEM/08/083, July 2008 <sup>[32]</sup> where a price of €47.124

<sup>32</sup> All Island project (AIP) Consultation Paper AIP/SEM/08/083: "Single Electricity Market – Fixed Cost of a Best New Entrant – Peaking Plant for the Calendar Year 2009", 4 July 2008

per MWh is given for peaking plant for 2009. PB Power estimates that this figure is a little too high for the average cost of fuel, and has selected €40 per MWh, or €0.04 per kWh for the purpose of this study.

411. Associated with energy losses is the generation capacity that must be made available to supply these energy losses. This generation capacity is a real requirement – it must be installed. In reality the capacity is paid for as a lump sum at the time of its installation, but its cost may be considered as an annualised running cost associated with the energy losses, and known as “power losses”. Power losses have been calculated here assuming a peak power flow of 750 MVA, and use a long run marginal cost (LRMC) of generation of €81.7 per kW per annum, plus 30% of this figure for transmission. The former figure has been quoted from Table 7 (page 31) of the same AIP consultation paper AIP/SEM/08/083. The latter percentage is taken from PB Power’s knowledge of world markets.

### 8.3.3 HVAC OHL replacement cost

412. The equipment replacement cost assumes a 40 year life. The amount of hazardous material in an OHL is negligible, but the structure includes a large amount of recyclable material. For the purpose of this document the cost of demolishing the OHL and disposing of the material is estimated to be 5% of the initial capital costs. This has been added to the full replacement cost in year 40, and the present value of this future cash flow has been added to the overall whole-of-life cost of the OHL.
413. The period before which the OHL equipment is replaced is assumed to be 40 years, a figure that is used by default by the NGET Connection Charging Statement<sup>[33]</sup> when depreciating assets. However, note that OHL towers are sometimes considered to have indefinite lives – that is, with appropriate care and maintenance they can survive ad infinitum, with corroding or damaged components being replaced as and when necessary. Conductor systems, however, (the conductors, insulators, and fittings) are more often seen to require replacement as a bulk item. The period before which such a replacement becomes necessary would depend substantially upon the prevailing weather conditions and pollution (both from industrial plant and from natural sources such as sea salt spray). Experience to date suggests that prudent replacement for 400kV conductor systems in average environmental conditions would occur at around 40 years.
414. That said, in the event that a strategic circuit cannot be taken out of service for re-conductoring for operational reasons, it may be necessary to build a second OHL and then refurbish or decommission the original. For this reason the full construction costs in 40 years time are included in these cost estimates (Note: The OHL replacement cost at its end-of-life only amounts to some 3% of the overall present value of the Project, as may be seen in the sample DCF table.).
415. Table 8-4 shows one of the DCF calculations made for OHL.

---

<sup>33</sup> “The Statement of the Connection Charging Methodology”, effective from 1 April 2008, NGET, Glossary, P38.

Table 8-4 - Overhead Line Discounted Cash Flow Example

OHL - 400kV "I-V-I" towers - 600sqmm Curlew ACSR - 2 Condr /ph - 500MW Load								
Year	Energy Losses (GWh.pa)	Power losses @ 750MVA load (MW)	Costs (€M)					Total Annual Cashflow
			Circuit Construction Capital	IDC & 40 year Replacement	Annual Energy Losses	Annualised Power Losses	Annual O&M	
1			39.0	1.5				40.5
2			39.0	4.4				43.5
3	54.6	13.9			2.2	1.5	0.2	3.8
4	54.6	13.9			2.2	1.5	0.2	3.8
5	54.6	13.9			2.2	1.5	0.2	3.8
6	54.6	13.9			2.2	1.5	0.2	3.8
7	54.6	13.9			2.2	1.5	0.2	3.8
8	54.6	13.9			2.2	1.5	0.2	3.8
9	54.6	13.9			2.2	1.5	0.2	3.8
10	54.6	13.9			2.2	1.5	0.2	3.8
11	54.6	13.9			2.2	1.5	0.2	3.8
39	54.6	13.9			2.2	1.5	0.2	3.8
40	54.6	13.9		81.9	2.2	1.5	0.2	85.8
<b>Total</b>	2,074		78.0					
<b>PV</b>			<b>75.3</b>	<b>10.3</b>	<b>25.0</b>	<b>17.0</b>	<b>1.8</b>	<b>129.4</b>

NB. - The "Circuit Construction Capital" column shows the total estimated capital expenditure for the OHL, split into the two years of construction works assumed for this study.

## 8.4 HVAC Cable Costs

416. The design of an UGC installation involves careful judgement, since many interdependent variables are presented to the designer. Example variables include:
1. the cable route
  2. the cable rating (maximum and continuous requirements),
  3. the material and cross section of the cable conductor and conductor surface treatment,
  4. the metallic barrier (sheath) material, and use and thickness of screening wires,
  5. the spacing of the conductors in the trench,
  6. the number of conductors per phase,
  7. the depth of the cable below ground, and the backfill thermal conductivity
  8. the ambient temperature of the region, and
  9. the location of cable joints and the distances between them.
417. These factors, and many others - especially those dealing with the cooling and the manner in which the cable is housed underground - all affect the rating and cost of the cable itself, the cost and disruption of the construction process, and the degree of heating that is evident at the surface when the cables are in operation.
418. It is not necessary to cost all these options to establish the feasibility of installing an UGC on the proposed 400kV connection route, however it is necessary to assume some configuration against which cost estimation may proceed. Some of the main assumptions are listed next, in Table 8-5.

**Table 8-5 - Cable Parameters: Assumptions**

Voltage Rating:	400kV
Capacity:	1500MVA continuous (2165 Amps per phase)
Number of cable cores per phase:	2 (therefore total of 6 phase cable cores)
Cable type:	1200mm <sup>2</sup> aluminium conductor, lead sheath
Method of burial	Direct, at 750mm centres spacing, and about 1000mm cover to ground level. The 2 phase cores to be buried in separate trenches spaced at 5000mm between centres (not ducted, except at crossings).
Loading for loss calculations	500MVA (as for OHL)
Other parameter assumptions are to be found in Table 3-2	

419. There are three overall aspects to the cost estimates for underground cables. These are:
1. Capital costs of construction but including, for example, negotiation with landowners, temporary access arrangements, and accommodation of other services,
  2. Operational costs, both maintenance and losses, capitalised to today's value, and
  3. Replacement cost in 40 years, estimated at today's value.
420. These three elements have been included in a whole-of-life discounted cash flow (DCF) analysis, and each is now considered in turn.

#### **8.4.1 HVAC cable capital costs**

421. In reality, the construction of UGC circuits for the Meath – Cavan – Tyrone route would represent a construction schedule of at least 3 – 4 years. For a given commissioning date, this would thus mean starting work on an UGC earlier than for an OHL. Alternatively, a later delivery of the benefits from the circuit would be suffered if work started at the same time as would have been the case for an OHL. However, to provide a DCF table that is easily comparable with the OHL version, two years has been assumed for this cost estimate calculation.
422. The same IDC rules have been applied here as for the OHL, however, in reality significantly more IDC would be incurred, making the UGC option increasingly less financially attractive.
423. The costs for a connection by UGC comprise the following:
- Civil works to establish temporary (heavy duty) roadway access, trenches and reinstatement,
  - Electrical cables and equipment for the connection, both supply and install, and
  - Electrical equipment for reactive compensation (voltage control), both supply and install at locations every 30km or so along the route. (This assumption is based upon limiting voltage regulation along the route to around 4%, and is just one of many possible solutions to the reactive compensation issue.)
424. Each of these is now considered in turn.

##### **8.4.1.1 HVAC cable Civil Works**

425. The civil works would be a significant undertaking for manpower, machinery and time. Apart from work on temporary haul road access and trenches along the route, preliminary works and general charges would need to be considered at "lump sum" intervals along the corridor.

426. Estimated unit setup costs are shown in Table 8-6. They include provision for archaeological monitoring, reporting and excavating based upon the experiences of the contractors who installed the South–North gas pipeline in 2005-2006 on behalf of BGE (Northern Ireland). This 154km pipeline runs from Gormanstown in County Meath to Ballyclare in County Antrim<sup>[34]</sup>.

**Table 8-6 – Civil Engineering – Preliminary Works Costs**

Civil Preliminary Works and General Charges for Overall Route	Estimate (£)	Estimate (€)
Construction (including plant, equipment, mobilisation supervision for all suppliers)	4,065,000	5,083,489
Surveys, photographic & engineering records	1,152,834	1,441,677
Other (including security, storage, communications, welfare, reinstatement)	5,854,172	7,320,939
<b>Total</b>	<b>11,072,006</b>	<b>13,846,105</b>

427. Table 8-7 presents these estimates allocated across sections of the route, and with contingency added.

**Table 8-7 – Civil Engineering – Preliminary Works Costs by route section**

Civil Preliminary Works and General Charges for Overall Route, including contingency	Meath-Cavan EirGrid (€)	Cavan-Tyrone EirGrid (€)	Cavan-Tyrone NIE (€)	Totals (€)
1. Proportion of these charges apportioned to each section of the route	40%	35%	25%	100%
2. Apportioned charges :	5,538,442	4,846,137	3,461,526	13,846,105
3. Contingency for preliminary works & general charges @ 10%:	553,844	484,614	346,153	1,384,610
<b>Totals for preliminary works &amp; general charges</b>	<b>6,092,286</b>	<b>5,330,750</b>	<b>3,807,679</b>	<b>15,230,715</b>

428. Estimated costs per km for the civil works are provided in Table 8-8. Also included there is the addition of a 15% contingency for undergrounding work, as discussed earlier.
429. As might be imagined, the type of terrain through which the cable trenches pass will have an effect on the costs per km. Before the civil estimating engineer visited site a number of different types of landscape were identified along the route search corridor (see Section 7.4 for further details). The civil cost estimates were then prepared with these terrain types in mind, in order to better reflect the costs that might be encountered. For the purposes of this cost study two trenching rates were seen as

<sup>34</sup> Further details on the South–North gas pipeline project can be found at [www.bordgais.ie/networks](http://www.bordgais.ie/networks).

adequate –one to cover Landscape Patterns 1 and 2, and one to cover all the other landscape patterns (2a, 2aa, 2ab, 2b and 2bb). Both rates are provided in Table 8-8.

**Table 8-8 – Civil Engineering – Estimated Costs per km**

Schedule of UGC civil works per km rates:	Estimate (£/km)	Estimate (€/km)
A. Trench Preparation: (including trenching, shuttering, backfilling and reinstating, but not cable-pulling)		
1. Landscape types 1 & 2 (cost per km)	543,335	679,468
2. Landscape types except 1 & 2 (cost per km)	580,643	726,123
B. Cable Installation - both landscape types:	191,153	239,047

Exchange rate = 1.2506 Euros per GBP

Schedule of UGC civil works per km rates, inc. contingency:	Unit cost (€/km)	Contingency (%)	Unit cost total (€/km)
A. Trench Preparation: (including trenching, shuttering, backfilling and reinstating, but not cable-pulling)			
1. Landscape types 1 & 2 (cost per km)	679,468	15%	781,389
2. Landscape types except 1 & 2 (cost per km)	726,123	15%	835,042
B. Cable Installation - both landscape types:	239,047	10%	262,951

430. Whilst it is possible to trench the fields and smaller roads of the route search corridor, this is not a practical operation when it comes to major roads, motorways and rivers. In this situation alternative ways must be found to effect a safe and reliable crossing without jeopardising the rating of the cable. Bridges are occasionally employed for this purpose, but a common technique used for pipelines and cables is horizontal directional drilling (HDD) to provide a trench-less solution.
431. The connection under consideration would require six single-phase cores of cable so seven boreholes would need to pass beneath each obstruction, the seventh being for earthing and other purposes. Each such borehole would be of the order of 250mm in diameter, and would probably be lined with a clean MDPE duct ready for the drawing in of the main cable cores. The raw costs per metre of seven such lined boreholes are shown in Table 8-9.



**Table 8-9 – Trenchless Crossings – Unit Cost**

<b>Directional drilling unit cost estimate (7 bores, per metre):</b>	<b>(£/m)</b>	<b>(€m)</b>
1. Estimated cost per metre (1 x 250mm dia core) so,	500	625
2. Estimated cost per metre (7 x 250mm dia cores)		4,377
3. Geological uncertainty factor (30%), see text		1,313
4. Estimated cost /m (7 cores) incl. uncertainty factor		5,690

432. HDD is a well established technique to allow crossings of large obstructions without disrupting traffic or water flow. However, it is still fraught with uncertainty since there is often very incomplete information about the ground to be drilled, and by the nature of the equipment being used mishaps are not infrequent (either in the form of lost or damaged equipment or a halt to the drilling operation for some other reason. One reason for such a halt might be drilling fluid breaking out of the borehole up through natural fissures into the river, requiring substantial remedial measures to be taken before drilling could proceed. To take account of these extraordinary uncertainties a geological uncertainty factor of 30% has been applied in Table 8-9 (for the HDD activity only) in addition to the normal 15% undergrounding contingency (for which see Table 8-10 below).
433. These figures allow the cost of various sizes of crossings to be estimated. The crossing types considered in this report, and their estimated costs, with contingency, are shown in Table 8-10.
434. It may be noted that whilst the underground works are accorded a 15% contingency factor, only a 10% contingency factor is considered appropriate for the preliminary works and general charges.

**Table 8-10 – Special Civil Works Lump Sum Costs**

<b>Schedule of directional drilling costs:</b>	<b>Unit cost (€)</b>
1. Trenchless Crossing - Large River @ 150m	853,501
2. Trenchless Crossing - Medium River @ 70m	398,300
3. Trenchless Crossing - Road @ 40m	227,600
4. Trenchless Crossing - Motorway @ 70m	398,300

435. The numbers of each type of trenchless crossing for each section of the route corridor have been estimated from maps, aerial photographs, and from sampling visits to the

proposed search corridor. The top of Table 8-11 shows the results of these estimates, and below that the costs for each route section are summarised.

**Table 8-11 - Special Civil Works Lump-Sum Costs by Route Section**

Numbers of crossings, by route section:	Meath-Cavan EirGrid	Cavan-Tyrone EirGrid	Cavan-Tyrone NIE	Totals
1. Trenchless Crossing - Large River @ 150m	2	0	1	3
2. Trenchless Crossing - Medium River @ 70m	22	15	11	48
3. Trenchless Crossing - Road @ 40m	5	6	4	15
4. Trenchless Crossing - Motorway @ 70m	2	1	0	3

Directional drilling costs, including contingency, by route section	Meath-Cavan EirGrid (€M)	Cavan-Tyrone EirGrid (€M)	Cavan-Tyrone NIE (€M)	Totals (€M)
1. Trenchless Crossing - Large River @ 150m	1.71	0.00	0.85	2.56
2. Trenchless Crossing - Medium River @ 70m	8.76	5.97	4.38	19.12
3. Trenchless Crossing - Road @ 40m	1.14	1.37	0.91	3.41
4. Trenchless Crossing - Motorway @ 70m	0.80	0.40	0.00	1.19
Totals	12.40	7.74	6.15	26.29
5. Contingency for underground crossings @ 15%:	1.86	1.16	0.92	3.94
Total costs of underground crossings	14.26	8.90	7.07	30.23

#### 8.4.1.2 HVAC Cable Supply and Install Costs

436. Broadly speaking the UGC themselves are little affected by the type of terrain they pass through, however there are certain constraints, particularly affecting the cable joints, which are imposed by the terrain and by the overall cable system design. Importantly for this study is the rating of the cable, the need for two cores per phase, and the result of a least-cost calculation that determines the cable core spacing across the trench needed to avoid overheating the UGC. This spacing itself can have a “knock-on” effect for the distance between cable joints and thus for the cable section lengths delivered on drums.
437. Another factor affecting the cable section length delivered on the drum is the availability of space in the landscape for joint bays. In addition, where the terrain constrains joint bay siting, safety considerations (sheath voltages) sometimes limit the length of cable sections.
438. A site visit by the cable system design engineer determined that, for the purposes of this feasibility study, two lengths of cable section would probably suffice to accommodate the terrain of the route search corridor – 690m and 625m. However, a shorter cable section implies more joints for a given circuit length and thus higher costs per km for the cable system. (Table 8-16 summarises the components that go to make up the cable system cost, and provides unit costs (supply and install) for both drum-lengths.)

439. The contingency factor applied here is 10% since it relates to manufacture, delivery, and installation of cable into pre-excavated trenches. The unknowns associated with the geological conditions would thus have been overcome already with the civil engineering contracts.
440. These elements are summarised in the following Table 8-12:

**Table 8-12 – Summary of Civil Works Lump-Sum Costs, by Route Section**

Total special civil costs, including contingency by route section	Meath-Cavan EirGrid (€M)	Cavan-Tyrone EirGrid (€M)	Cavan-Tyrone NIE (€M)	Totals (€M)
1. Civil preliminary works and general charges:	6.09	5.33	3.81	15.23
2. Directional drilling:	14.26	8.90	7.07	30.23
Total special civil costs	20.36	14.23	10.87	45.46

#### 8.4.1.3 HVAC Cable Reactive Compensation Capital Costs

441. The electrical capacitance added to the transmission system by an UGC connection is considerably higher than that from the equivalent overhead line. This extra capacitance has a marked effect on the system voltage, and must be counteracted to avoid dangerous or damaging voltages.
442. For relatively short lengths of UGC this mitigation, known as reactive compensation, is normally applied at the terminating substations. However the circuit lengths under consideration here are so great that for this cable estimate it has been assumed that three intermediate reactive compensation compounds (IRCC) would be required in addition to compensation at each of the three substations. (It should be noted that there are several different technical solutions to this problem, and this assumption represents just one of the possibilities.)
443. The effects on the two transmission networks of losing the cable circuit suddenly due to some form of fault has not been studied by PB Power, however, since the amount of reactive compensation required under such circumstances might vary considerably and instantaneously, it seems appropriate that, whilst the intermediate compensation is formed of shunt reactors, that at the terminating substations should be costed as static Var compensators (SVC).
444. Since two cable cores per phase would be required to transmit the 1500MVA rated load of the connection, an opportunity would arise regarding the system design. For relatively little additional cost it would be practicable to keep the two phase cores electrically separate throughout the lengths of the circuit sections, and this would allow the prospect of a double circuit instead of a single circuit connection. Without elaborating here the several benefits to system security, equipment maintainability,

and quality of supply, it should be noted that the effect on the IRCC costs would be an increase to cover doubling up of busbars, switchgear and protection. There would also be a nominal increase in land-use.

445. The following reactive compensation costs have assumed that:
- shunt reactors would be used at IRCCs,
  - SVCs would be used at terminating substations, and
  - Cable cores for each phase would be electrically separated along the lengths of the two circuits Woodland – Kingscourt and Kingscourt – Turleenan.
446. Table 8-13 provides the estimated costs for each IRCC. Some 0.5 hectare of reasonably flat land would be required for each IRCC, and its location along the circuits would not be critical within a few kilometres. However the reader should note that the table excludes the cost of purchase of this land, the estimate for which is beyond the scope of this report.
447. The costs for maintaining electrical separation of the cable cores along the length of the circuits is estimated at some €5M excluding the terminating switchgear bays at each substation.
448. Table 8-14 provides the estimated costs for each SVC. A similar amount of land would be required for each SVC as for the IRCCs, but this land would need to adjoin, or be incorporated within, the boundaries of the three 400kV substations under consideration here. As before, the reader should note that the table excludes the cost of purchase of this land.
449. Table 8-15 summarises the overall compensation costs that would be required if the 400kV connections were to be installed underground.

Table 8-13 – Intermediate Reactive Compensator Costs

Construction Costs - Each Intermediate Reactive Compensation Compound (IRCC)	1 core-per-phase				2 cores-per phase (NB-1)
	No. off per core	Unit Supply (€k)	Unit Install (€k)	Unit Totals (€k)	Unit Totals (€k)
<b>Electrical supply and commissioning:</b>					
400kV 200MVAr shunt reactor + civils and bund	1	1,848	406	2,254	4,508
400kV 1-ph cable sealing end (NB-2)	3	-	-	-	-
400kV busbar skeleton bay	1	635	254	889	1,778
400kV 1-ph surge arresters	3	17	4	61	123
400kV 3-ph earth switch	1	18	4	22	44
Cable protection, 2 ends	2	308	-	615	1,230
Shunt reactor and busbar protection - 2 zones	2	373	-	746	1,491
Total electrical (NB-2)		3,198	667	4,587	9,174
<b>Site preparation:</b>					
Land purchase (approx 0.5ha) (NB-3)	(Beyond scope of report)				
Services accommodation, 150m access road, relay house (NB-4)		15	30	45	45
Other Preparatory Civil works		80	70	150	300
Total site preparation and accommodations		95	100	195	390
Total per IRCC (NB-2)		3,293	767	4,061	8,121
Contingency @ 10%		329	77	406	812
<b>IRCC each, incl. contingency (NB-2)</b>		<b>3,623</b>	<b>844</b>	<b>4,467</b>	<b>8,934</b>

Table 8-14 – Static Var Compensator Costs

Construction Costs - Each SVC for circuit terminations (Woodland, Kingscourt, Turleenen)	Unit Supply (€k)	Unit Install (€k)	Unit Totals (€k)
<b><u>Electrical supply and commissioning:</u></b>			
400kV +/-150Mvar SVC (supply, commission and project management)	9,500	507	10,007
<b><u>Site preparation:</u></b>			
land purchase (approx 0.5ha) (NB-1)	-	-	-
services accommodation, 150m access road, relay house (NB-2)	-	-	-
Substation connections works	171	183	354
Total site preparation and accommodations	171	183	354
Total per SVC	9,671	690	10,361
Contingency @ 10%	967	69	1,036
<b>SVC each, incl. contingency</b>	<b>10,638</b>	<b>759</b>	<b>11,397</b>

Table 8-15 – Summary of Compensation Costs

Reactive Compensation costs for UGC Woodland - Kingscourt - Turleenen	Meath-Cavan EirGrid (€M)	Cavan-Tyrone EirGrid (€M)	Cavan-Tyrone NIE (€M)	Total (€M)
Cost of 3 IRCCs	8.93	8.93	8.93	26.80
Cost of 3 SVCs (one at each substation)	11.40	11.40	11.40	34.19
<b>Total reactive compensation costs (supply, install and contingency):</b>	<b>20.33</b>	<b>20.33</b>	<b>20.33</b>	<b>60.99</b>

#### 8.4.1.4 HVAC Cable Unit Capital Costs Summary

450. The following Table 8-16 draws together the various unit costs associated with UGC, and includes the electrical supply and install elements. Note that although a 5% project management cost has been added to these costs, this figure could rise appreciably if the cable installation work was externally managed.

**Table 8-16 – Underground Cable Unit Costs**

<b>UGC Cost per km estimates (including contingency)</b>	<b>Landscape types 1 &amp; 2 (€/km)</b>	<b>Landscape types except 1 &amp; 2 (€/km)</b>	<b>One-off costs per Overall Project (€M)</b>
Civils preliminary and special works, including mobilisation & directional drilling	-	-	45.46
Trench civils	0.78	0.84	
Civil supply - cable terminations	-	-	0.17
civil installation - cable pulling	0.26	0.26	
<b>Total civil works</b>	<b>1.04</b>	<b>1.10</b>	<b>45.63</b>
Total civil works with one-off costs apportioned over total length of connection	1.38	1.44	-
Cable electrical supply	1.82	1.86	1.45
Cable electrical installation	0.25	0.27	1.59
<b>Total cable electrical works</b>	<b>2.07</b>	<b>2.13</b>	<b>3.04</b>
Total cable electrical works with one-off costs apportioned over total length of connection	2.09	2.15	-
Total cable-end and intermediate reactive compensation	-	-	60.99
Total supply, install, and contingency unit rates	3.11	3.22	109.7
Project management (5%)	0.16	0.16	5.48
total unit rates, inc. project management	3.26	3.39	115.1
<b>Overall unit rates with one-off costs apportioned over total length of connection (135.3 km)</b>	<b>4.12</b>	<b>4.24</b>	<b>-</b>

#### 8.4.1.5 Applying the HVAC Cable Unit Capital Costs

451. The actual process of routeing an UGC through a search corridor is not simply a question of taking the mid-line through the corridor. Deviations from this ideal would be necessary to accommodate existing natural and man-made features.
452. Depending upon the nature of the landscape, different length allowance factors may be estimated in order to account for the extra length of cable required to circumnavigate these features.
453. Table 8-17 lists the length of each type of terrain identified, shows the estimated length allowance that would be required, and calculates the resulting lengths of cable and trenching that would be required. Also shown in this table are the overall lengths of each route section.

Table 8-17 – Terrain Types, Corridor Lengths, Length Allowances

Terrain Area	Note	Terrain Pattern	Length (m)	Corridor Section	UGC Length Allowance (%)	Adjusted Length (m)	Cumulative Adjusted Lengths (m)
1	S of Turleenen	2aa	3,552	Cavan-Tyrone, NIE	5%	3,730	
2		2a	5,291	Cavan-Tyrone, NIE	5%	5,556	
3	River Blackwater (NI)	RC1	150	Cavan-Tyrone, NIE	10%	165	
4		2aa	2,364	Cavan-Tyrone, NIE	5%	2,482	
5		2a	14,964	Cavan-Tyrone, NIE	5%	15,712	
6	N of Border	2	4,340	Cavan-Tyrone, NIE	3%	4,470	<b>32,115</b>
7	S of Border	2	4,003	Cavan-Tyrone, EirGrid	3%	4,123	
8		2ab	8,272	Cavan-Tyrone, EirGrid	10%	9,099	
9		2b	2,822	Cavan-Tyrone, EirGrid	10%	3,104	
10		2a	21,554	Cavan-Tyrone, EirGrid	5%	22,632	
11	N of Kingscourt	2b	8,013	Cavan-Tyrone, EirGrid	10%	8,814	<b>47,772</b>
12	S of Kingscourt	2b	2,800	Meath-Cavan, EirGrid	10%	3,080	
13		2bb	9,783	Meath-Cavan, EirGrid	10%	10,761	
14		1	11,711	Meath-Cavan, EirGrid	3%	12,062	
15	River Blackwater (Rol)	RC2	150	Meath-Cavan, EirGrid	10%	165	
16		1	12,342	Meath-Cavan, EirGrid	3%	12,712	
17	River Boyne	RC3	150	Meath-Cavan, EirGrid	10%	165	
18	N of Woodland	1	15,967	Meath-Cavan, EirGrid	3%	16,446	<b>55,392</b>
	<b>Totals</b>		<b>128,228</b>			<b>135,279</b>	<b>135,279</b>



454. It may be noted that the overall length of this UGC search corridor and adjusted route length are a little shorter than the proposed 140km OHL. This measurement has been obtained not by following any of the proposed OHL route options, but by measuring the length of the centre-line of the UGC search corridor, and then augmenting these figures with nominal “length allowances” to accommodate a degree of variation of any practical cable route from this centre-line (see column 6 of Table 8-17). The resulting estimates are considered to be conservative cable length estimates. Whilst the calculations in this study have used these assumptions, no detailed UGC route has been established, and it could easily be that, in practice, an UGC route would turn out to be significantly longer than these estimates, with a commensurate increase in overall costs.
455. Table 8-18 provides the lengths of each type of terrain existing in each of the three route corridor sections, whilst Table 8-19 provides the associated drum lengths and unit costs.

**Table 8-18 – Terrain Pattern Lengths by Corridor Section**

Terrain Pattern	Corridor Section length (m)			
	Meath-Cavan, EirGrid	Cavan-Tyrone, EirGrid	Cavan-Tyrone, NIE	Whole Route
1	41,551			41,551
2		4,123	4,470	8,593
2a		22,632	21,433	44,064
2aa			6,212	6,212
2ab		9,099		9,099
2b	3,080	11,919		14,999
2bb	10,761			10,761
<b>Totals</b>	<b>55,392</b>	<b>47,772</b>	<b>32,115</b>	<b>135,279</b>
	40%	35%	25%	100%

**Table 8-19 – Terrain Pattern, Drum Lengths and Unit Costs**

Terrain Pattern	Drum Length (m)	UGC unit cost per km (€M)
1	690	4.12
2	690	4.12
2a	625	4,24
2aa	625	4,24
2ab	625	4,24
2b	625	4,24
2bb	625	4,24

456. Table 8-20 takes the corridor section lengths and UGC unit costs developed above and shows the calculated installed cost estimate by corridor section, and the associated totals.

**Table 8-20 – UGC Installed Costs, by Corridor Section**

Terrain Pattern	Overall Unit cost (€M/km)	Corridor Section UGC Cost Estimates			
		Meath-Cavan, EirGrid (€M)	Cavan-Tyrone, EirGrid (€M)	Cavan-Tyrone, NIE (€M)	Whole Route (€M)
1	4.12	171.0			171.0
2	4.12		17.0	18.4	35.4
2a	4.24		95.9	90.8	186.7
2aa	4.24			26.3	26.3
2ab	4.24		38.6		38.6
2b	4.24	13.1	50.5		63.6
2bb	4.24	45.6			45.6
<b>Totals</b>		<b>229.7</b>	<b>201.9</b>	<b>135.5</b>	<b>567.1</b>

#### 8.4.2 HVAC UGC Operational costs

457. UGC operations (losses), and maintenance costs have been estimated over a nominal 40 year life and have been included in the capital sums whole-of-life discounted cash flow analysis. Certain assumptions have been made regarding these quantities, as follows:-

##### 8.4.2.1 HVAC UGC - maintenance costs

458. UGC maintenance costs are estimated as a percentage per annum of the capital value – see Table 8-21– and are considered to include regular route safety patrols and link-box tests at approximately 2 year intervals. These tests are part of the safety

and cable integrity monitoring process, but would need to be performed whilst the circuit is out of service.

#### 8.4.2.2 HVAC UGC - reactive compensation station maintenance costs

459. These maintenance costs are estimated as a percentage per annum of the capital value of the compensation equipment – see Table 8-21. This includes periodic switchgear maintenance and reactor oil processing. The switchgear would need to be taken out of service periodically, though infrequently, for maintenance, and it is assumed here that this would be performed at the same time that the circuit termination switchgear is maintained, to avoid additional planned outage periods. Shunt reactor oil could be processed whilst the circuit is in service.

**Table 8-21 – UGC Maintenance Costs**

Cash Flow Discount Rate =	7.6%
O&M - UGC (% of capital value pa) =	0.025%
O&M – IRCC + SVCs (% of capital value pa) =	0.50%

#### 8.4.2.3 HVAC UGC - costs of lifetime losses

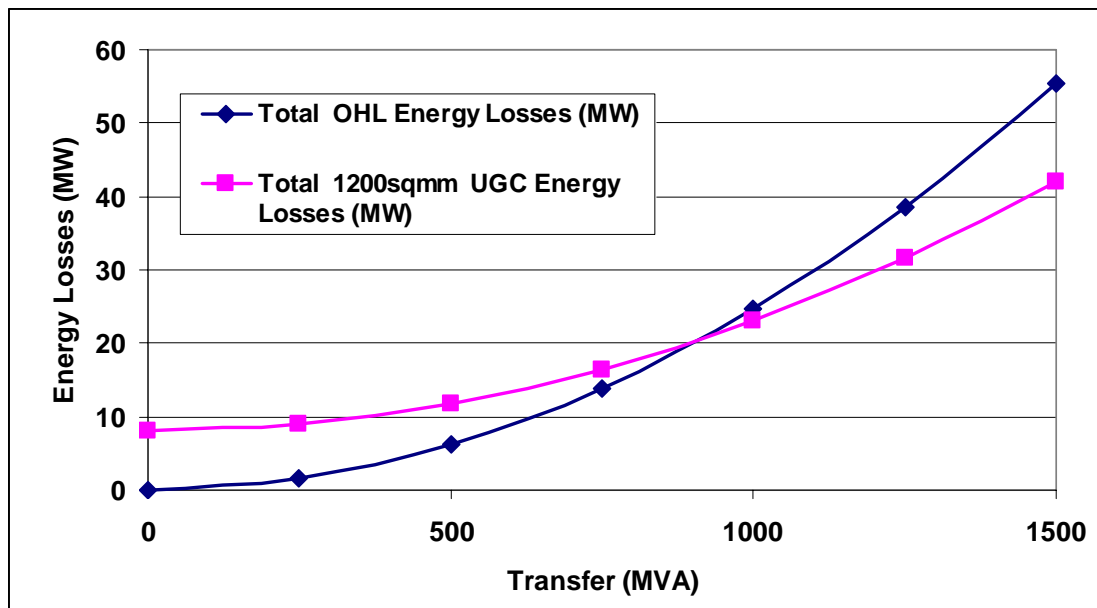
460. Based upon information provided by EirGrid and NIE, PB Power has used a power transfer of 500MVA to assess the costs of lifetime losses in the circuit and any associated reactive compensation. It may be seen that OHL tends to have lower running costs for average transfers of less than about 800MVA. These total losses for OHL and UGC have been compared in Figure 8-1. They have been costed by using a short run marginal cost (SRMC) of generation - i.e. fuel cost - of €0.04/kWh. This figure has been derived from page 28 of AIP consultation paper AIP/SEM/08/083, July 2008 [35] where a price of €47.124 per MWh is given for peaking plant for 2009. PB Power estimates that this figure is a little too high for the average cost of fuel, and has therefore selected €40 per MWh, or €0.04 per kWh for the purpose of this study.

461. Power losses have been calculated assuming a peak power flow of 750 MVA, and use a long run marginal cost (LRMC) of generation of €81.7 per kW per annum, plus 30% of this figure for transmission. The former figure has been quoted from Table 7 (page 31) of the same AIP consultation paper AIP/SEM/08/083. The latter percentage is taken from PB Power's knowledge of world markets. As was discussed for the OHL option, the results of this study are presented both with and without the power losses element.

462. Wayleaves costs, as with the costs of landowner compensation, have been excluded from these calculations.

<sup>35</sup> All Island project (AIP) Consultation Paper AIP/SEM/08/083: "Single Electricity Market – Fixed Cost of a Best New Entrant – Peaking Plant for the Calendar Year 2009", 4 July 2008

Figure 8-1 – Comparison of Energy Losses for OHL and UGC



#### 8.4.3 HVAC Underground Cable End-of-Life Replacement Cost

463. The equipment replacement cost assumes a 40 year life. The amount of hazardous material in an UGC is negligible, but there is a large amount of recyclable material. For the purpose of this document the cost of removing the UGC and its fittings and disposing of the material is estimated to be 5% of the initial capital costs. This has been added to the full replacement cost in year 40, and the present value of this future cash flow has been added to the overall whole-of-life cost of the UGC.
464. The period before which the UGC equipment is replaced is assumed to be 40 years, a figure that is used by default by the NGET Connection Charging Statement<sup>[36]</sup> when depreciating assets. Cable joints are viewed as the least reliable part of a cable system, so a transmission company suffering increased unavailability of an ageing cable connection is likely to opt for a complete circuit replacement rather than a piecemeal approach (as may be adopted for an OHL).
465. However, in the event that a strategic circuit cannot be taken out of service for re-conductoring for operational reasons, it may be necessary to construct a second UGC connection in parallel with the first, and then refurbish or decommission the original. For this reason the full construction costs in 40 years time are included in these cost estimates. (Note: The present value of the cost of the UGC replacement at its end-of-life amounts to some 5% of the overall cost of the Project.)
466. Table 8-22 shows one of the DCF calculations made for UGC.

<sup>36</sup> "The Statement of the Connection Charging Methodology", effective from 1 April 2008, NGET, Glossary, P38.

Table 8-22 – Underground Cable Discounted Cash Flow Example

Cable - 400kV XLPE - 1200 sqmm Aluminium - 2 Core/ph - 500MW Load, 400Mvar Comp every 30km:								
Year	Energy Losses (GWh.pa)	Power losses @ 750MW load	Costs (€M)					Total Annual Cashflow
			Circuit Construction Capital	IDC & 40 year Replacement	Annual Energy Losses	Annualised Power Losses	Annual O&M	
1			283.6	10.8				294.3
2			283.6	32.3				315.9
3	103.2	16.5			4.1	1.8	0.4	6.3
4	103.2	16.5			4.1	1.8	0.4	6.3
5	103.2	16.5			4.1	1.8	0.4	6.3
6	103.2	16.5			4.1	1.8	0.4	6.3
7	103.2	16.5			4.1	1.8	0.4	6.3
8	103.2	16.5			4.1	1.8	0.4	6.3
9	103.2	16.5			4.1	1.8	0.4	6.3
10	103.2	16.5			4.1	1.8	0.4	6.3
11	103.2	16.5			4.1	1.8	0.4	6.3
39	103.2	16.5			4.1	1.8	0.4	6.3
40	103.2	16.5		595.5	4.1	1.8	0.4	601.8
<b>Total</b>	3,921		567.1					
<b>PV</b>			<b>547.1</b>	<b>75.0</b>	<b>47.4</b>	<b>20.1</b>	<b>5.1</b>	<b>694.7</b>

NB - The “Circuit Construction Capital” column shows the total estimated capital expenditure for the UGC system plus the “per km” civil costs, split into the two years of construction works assumed for this study.

### 8.5 HVDC Costs

- 467. Since earlier chapters indicate that this Project does not represent an ideal application for HVDC, much less discussion is devoted here to the costs of this option. However, outline figures of HVDC capital and lifetime costs are presented and are then compared with those of the HVAC OHL option already discussed.
- 468. Summary costs are presented in Table 8-23. Because of the very uncertain track record of multiple terminal HVDC links, this table assumes that the links between Co. Meath and Co. Cavan, and between Co. Cavan and Co. Tyrone, would be electrically separate.

**Table 8-23 – Comparative costs of HVDC solutions**

	Converter (€M)		Circuit (€M)		Totals (€M)	HVDC Cost Ratios
	Build	Running	Build	Running		
<b>Overhead Line:</b>						
LCC	313	58	73	21	464	Base case
VSC	482	90	78	22	671	1.4
<b>Underground Cable:</b>						
LCC **	313	58	311	46	729	1.6
VSC	482	90	370	36	978	2.1

\*\* Note: the line indicated thus will be used for costings in this study.

- 469. For HVDC overhead line, a 1500MW rating a LCC scheme is likely to be most economic as a modified bipole at  $\pm 350\text{kVdc}$  with all aluminium conductors (AAAC) at  $2 \times 700\text{mm}^2$ . For a VSC transmission scheme, two parallel links at  $\pm 300\text{kVdc}$  with all aluminium conductors (AAAC) at  $2 \times 700\text{mm}^2$  are costed.
- 470. For HVDC underground cable, an LCC HVDC land cable scheme is likely to be most economic as a modified bipole operating at  $\pm 450\text{kVdc}$  and using two cables each with  $2500\text{mm}^2$  copper conductors. For the VSC transmission solution two parallel operated schemes, each at  $\pm 300\text{kVdc}$ , with two cables each of  $1500\text{mm}^2$  are costed.
- 471. An HVDC LCC installation would be equivalent to a single circuit 400kV AC line, whilst the VSC alternatives would effectively offer two lower rated circuits in parallel, and would thus be equivalent to a double circuit AC connection.
- 472. It may be seen from Table 8-23 that, for HVDC, the classical LCC technology is less costly than the more electrically versatile VSC alternative. Since the purpose of this document is to explore the viability of undergrounding the proposed single circuit OHL, an LCC HVDC UGC link will be adopted here for this UGC costing comparison.
- 473. From the UGC LCC line of Table 8-23 the following is evident (a rounding error occurs in line 1 of this table):-

	Building costs – Converter	Building costs – Circuit	Total Build Costs
UGC LCC (€M)	313	311	625

And,

	Running Costs - Converter	Running Costs - Circuit	Total Running Costs
UGC LCC (€M)	58	46	104

474. For the capital costs, assuming a present value of €624.9M and a 2 year build schedule, this would be equivalent to a capital cost of €647.8M. This 2 year build schedule (as for the AC options) and similar assumptions for end-of life replacement, yields an IDC of around €49.2M and a 40 year replacement sum of €680.2M. Incorporating the €103.7M lifetime running costs (O&M and losses) yields an overall present cost of around €814.3M. This is the basic figure used in the tables in the next section (line 6 of Table 8-24 ) where costs are summarised and compared.
475. A new and substantial strategic spares holding of HVDC equipment would need to be established to maintain the quoted availability. This aspect would need to be included in any detail Project design and costing exercise, and would considerably outweigh any HVAC strategic spares holding that might be required for the Project. However, for comparison purposes, since strategic spares have not been included in the HVAC cost estimates, they have not been included in the HVDC cost estimates either.
476. It should be noted that there has been much less recent HVDC construction activity in the world than HVAC so, whilst these figures represent “best estimates” there is additional uncertainty about their present validity. With this in mind, therefore, when final comparisons are made, a sensitivity calculation is also presented – see Section 8.8.

## 8.6 Summary of Costs

477. Based on the costs provided in preceding sections, three connection alternatives have been compared in Table 8-24 (in Euros on the first page, and the equivalent in Pounds Sterling on the second page). The alternatives are:
- HVAC OHL – column 1,
  - HVAC UGC – column 2, and
  - HVDC UGC – column 3.
478. Line 1 of the table confirms that the figures relate to the whole route, whilst line 2 confirms what that route length is for the OHL and the UGC calculations.
479. Lines 3 – 5 summarise the capital costs of the Project.
480. Line 6 provides the whole-of-life costs of the alternatives, having processed all anticipated cash flows with a DCF analysis. These estimates include construction

costs, interest during construction (IDC), lifetime energy losses, annualise power losses, and replacement of the connection 40 years after construction.

481. Lines 7 – 12 provide a breakdown of whole-of-life cost estimate into construction, running costs, and 40 year replacement.



Table 8-24 – Summary Costs Comparison – Whole Route (Euros)

Summary Comparison - Euros Table		Col 1	Col 2	Col 3	Col 4	Col 5	Col 6	Col 7
Line No.	Item	AC OHL	AC UGC	LCC DC UGC	AC OHL - AC UGC differences	AC OHL - DC UGC differences	AC OHL-UGC difference factor	AC OHL-DC UGC difference factor
1	Route	Whole Route	Whole Route	Whole Route	Whole Route	Whole Route	Whole Route	Whole Route
2	Route Length (km)	128	135	135	7	7	1.1	1.1
3	Total Route Construction Cost (€M)	78	567	648	489	570	7.3	8.3
4	of which, Reactive Compensation Cost (€M)	0	61	not separately costed	61	n/a	-	n/a
5	of which, Special Civils Cost (€M)	0	45	not separately costed	45	n/a	-	n/a
6	<b>Whole Life Cost, including Construction, IDC, lifetime energy losses costs, annualised power losses and 40 year replacement (€M, rounded)</b>	<b>129</b>	<b>695</b>	<b>814</b>	<b>565</b>	<b>685</b>	<b>5.4</b>	<b>6.3</b>
	Comprising:							
7	1. PV of Construction Costs +IDC (€M)	81	588	672	507	591	7.3	8.3
8	Construction Costs as %	58%	79%	77%				
9	2. PV of Maintenance and Losses Costs (€M)	44	73	104	29	60	1.7	2.4
10	O&M and Losses Costs as %	34%	10%	13%				
11	3. PV of 40 year replacement Costs (€M)	5	34	39	30	34	7.3	8.3
12	40 year replacement Costs as %	8%	11%	11%				

Note: Totals subject to rounding error

Table 8-25 – Summary Costs Comparison – Whole Route (Sterling)

Summary Comparison - Euros Table		Col 1	Col 2	Col 3	Col 4	Col 5	Col 6	Col 7
Line No.	Item	AC OHL	AC UGC	LCC DC UGC	AC OHL - AC UGC differences	AC OHL - DC UGC differences	AC OHL-UGC difference factor	AC OHL-DC UGC difference factor
1	Route	Whole Route	Whole Route	Whole Route	Whole Route	Whole Route	Whole Route	Whole Route
2	Route Length (km)	128	135	135	7	7	1.1	1.1
3	Total Route Construction Cost (€M)	78	567	648	489	570	7.3	8.3
4	of which, Reactive Compensation Cost (€M)	0	61	not separately costed	61	n/a	-	n/a
5	of which, Special Civils Cost (€M)	0	45	not separately costed	45	n/a	-	n/a
6	<b>Whole Life Cost, including Construction, IDC, lifetime energy losses costs, annualised power losses and 40 year replacement (€M, rounded)</b>	<b>129</b>	<b>695</b>	<b>814</b>	<b>565</b>	<b>685</b>	<b>5.4</b>	<b>6.3</b>
7	Comprising:							
7	1. PV of Construction Costs +IDC (€M)	81	588	672	507	591	7.3	8.3
8	Construction Costs as %	58%	79%	77%				
9	2. PV of Maintenance and Losses Costs (€M)	44	73	104	29	60	1.7	2.4
10	O&M and Losses Costs as %	34%	10%	13%				
11	3. PV of 40 year replacement Costs (€M)	5	34	39	30	34	7.3	8.3
12	40 year replacement Costs as %	8%	11%	11%				

Note: Totals subject to rounding error

482. In column 4 of Table 8-24 the differences between columns 1 and 2 (HVAC OHL and UGC) are shown, whilst in column 5 the differences between columns 1 and 3 (HVAC OHL and HVDC UGC) are provided.
483. In column 6 of Table 8-24 the ratios between columns 1 and 2 (HVAC OHL and UGC) are shown, whilst in column 7 the ratios between columns 1 and 3 (HVAC OHL and HVDC UGC) are provided.
484. The figures of Table 8-24 relate to the whole route. The equivalent tables for each route section, plus the whole route, are provided in Appendix 2 to Appendix 5, both in Euros and separately in Pounds Sterling.
485. These results are further summarised, and presented separately for each route section, in the following tables.

NOTE: Regarding the cost ratios that are presented in the following tables, the reader is urged to note that many factors and assumptions are embedded when such a complex project comparison is reduced to a single ratio in this way. Rarely are the assumptions behind two sets of ratios from different sources the same, and such cost ratios can vary very significantly with small changes to the underlying assumptions and costs. For this reason direct comparisons between ratios from different sources are usually not valid, and a consideration of the estimated costs themselves is usually more illuminating.

486. It may be seen from these tables that the ranking, by cost, of the transmission options considered here for this Project is as shown in Table 8-26:-

**Table 8-26 – Summary Costs Ranking – Whole Route**

Rank	Technology	Construction costs and IDC (€M)	Lifetime running costs (€M)	End-of-life replacement (€M)	Overall whole-of-life costs (€M)
1	HVAC OHL	81	44	5	129
2	HVAC UGC	588	73	34	695
3	HVDC UGC	672	104	39	814

Note: Totals subject to rounding error

487. This whole-route ranking order is also applicable to the individual Co. Meath – Co. Cavan and Co. Cavan – Co. Tyrone circuits.
488. Table 8-27 through to Table 8-30 presents a summary for each route section, and for the whole route, in both currencies.

Table 8-27 – Costs Overview – Co. Meath – Co. Cavan, EirGrid

Meath-Cavan, EirGrid					
AC OHL and AC UGC				AC OHL and DC UGC	
<b>Construction Costs + IDC</b>				<b>Construction Costs + IDC</b>	
	€M	£M		€M	£M
HVAC OHL	33	27	HVAC OHL	33	27
HVAC UGC	238	190	HVDC UGC	275	220
Difference	205	164	Difference	242	193
Difference (times)	7.1		Difference (times)	8.2	
<b>Lifetime Running Costs</b>				<b>Lifetime Running Costs</b>	
	€M	£M		€M	£M
HVAC OHL	18	14	HVAC OHL	18	14
HVAC UGC	29	24	HVDC UGC	42	34
Difference	11	9	Difference	24	19
Difference (times)	1.6		Difference (times)	2.3	
<b>40-year Replacement Cost</b>				<b>40-year Replacement Cost</b>	
	€M	£M		€M	£M
HVAC OHL	2	2	HVAC OHL	2	2
HVAC UGC	14	11	HVDC UGC	16	13
Difference	12	10	Difference	14	11
Difference (times)	7.1		Difference (times)	8.2	
<b>Overall Whole-of-Life Costs</b>				<b>Overall Whole-of-Life Costs</b>	
	€M	£M		€M	£M
HVAC OHL	53	43	HVAC OHL	53	43
HVAC UGC	281	225	HVDC UGC	333	267
Difference	228	182	Difference	280	224
Difference (times)	5.3		Difference (times)	6.2	

Note: Totals subject to rounding error

Table 8-28 – Costs Overview – Co. Cavan – Co. Tyrone, EirGrid

Cavan-Tyrone, EirGrid					
AC OHL and AC UGC				AC OHL and DC UGC	
<b>Construction Costs + IDC</b>				<b>Construction Costs + IDC</b>	
	€M	£M		€M	£M
HVAC OHL	28	23		28	23
HVAC UGC	209	167		237	190
Difference	181	145		209	167
Difference (times)	7.4			8.4	
<b>Lifetime Running Costs</b>				<b>Lifetime Running Costs</b>	
	€M	£M		€M	£M
HVAC OHL	15	12		15	12
HVAC UGC	26	20		37	29
Difference	10	8		21	17
Difference (times)	1.7			2.4	
<b>40-year Replacement Cost</b>				<b>40-year Replacement Cost</b>	
	€M	£M		€M	£M
HVAC OHL	2	1		2	1
HVAC UGC	12	10		14	11
Difference	11	8		12	10
Difference (times)	7.4			8.4	
<b>Overall Whole-of-Life Costs</b>				<b>Overall Whole-of-Life Costs</b>	
	€M	£M		€M	£M
HVAC OHL	45	36		45	36
HVAC UGC	247	198		288	230
Difference	202	162		242	194
Difference (times)	5.5			6.4	

Note: Totals subject to rounding error

Table 8-29 – Costs Overview – Co. Cavan – Co. Tyrone, NIE

Cavan-Tyrone, NIE					
AC OHL and AC UGC				AC OHL and DC UGC	
<b>Construction Costs + IDC</b>				<b>Construction Costs + IDC</b>	
		€M	£M		
HVAC OHL		19	15	HVAC OHL	
HVAC UGC		141	112	HVDC UGC	
Difference		121	97	Difference	
Difference (times)		7.3		Difference (times)	
<b>Lifetime Running Costs</b>				<b>Lifetime Running Costs</b>	
		€M	£M		
HVAC OHL		10	8	HVAC OHL	
HVAC UGC		18	14	HVDC UGC	
Difference		7	6	Difference	
Difference (times)		1.7		Difference (times)	
<b>40-year Replacement Cost</b>				<b>40-year Replacement Cost</b>	
		€M	£M		
HVAC OHL		1	1	HVAC OHL	
HVAC UGC		8	7	HVDC UGC	
Difference		7	6	Difference	
Difference (times)		7.3		Difference (times)	
<b>Overall Whole-of-Life Costs</b>				<b>Overall Whole-of-Life Costs</b>	
		€M	£M		
HVAC OHL		31	25	HVAC OHL	
HVAC UGC		166	133	HVDC UGC	
Difference		135	108	Difference	
Difference (times)		5.4		Difference (times)	

Note: Totals subject to rounding error

Table 8-30 – Costs Overview – Whole Route

Whole Route					
AC OHL and AC UGC				AC OHL and DC UGC	
<b>Construction Costs + IDC</b>				<b>Construction Costs + IDC</b>	
	€M	£M		€M	£M
HVAC OHL	81	65	HVAC OHL	81	65
HVAC UGC	588	470	HVDC UGC	672	537
Difference	507	405	Difference	591	472
Difference (times)	7.3		Difference (times)	8.3	
<b>Lifetime Running Costs</b>				<b>Lifetime Running Costs</b>	
	€M	£M		€M	£M
HVAC OHL	44	35	HVAC OHL	44	35
HVAC UGC	73	58	HVDC UGC	104	83
Difference	29	23	Difference	60	48
Difference (times)	1.7		Difference (times)	2.4	
<b>40-year Replacement Cost</b>				<b>40-year Replacement Cost</b>	
	€M	£M		€M	£M
HVAC OHL	5	4	HVAC OHL	5	4
HVAC UGC	34	27	HVDC UGC	39	31
Difference	30	24	Difference	34	27
Difference (times)	7.3		Difference (times)	8.3	
<b>Overall Whole-of-Life Costs</b>				<b>Overall Whole-of-Life Costs</b>	
	€M	£M		€M	£M
HVAC OHL	129	103	HVAC OHL	129	103
HVAC UGC	695	556	HVDC UGC	814	651
Difference	565	452	Difference	685	548
Difference (times)	5.4		Difference (times)	6.3	

Note: Totals subject to rounding error

## 8.7 Sensitivity to Sterling / Euro Exchange Rate

489. Since the exchange rate between Sterling and Euros has been very volatile at the time this study was prepared, sensitivity of the overall route results to the exchange rate was checked. Costs for the various options, and for the components within options, have been provided either in Pounds Sterling or in Euros, depending upon their availability for this study, so there is no straight-forward relationship between the overall estimated costs and the exchange rate. Generally speaking, however, more of the costs have been provided in Euros so, when changing the exchange rate, there is less of a difference in the Euro estimates than in the Pounds Sterling versions of the same estimates.
490. A comparison of Table 8-31 with Table 8-30 indicates that, if the Sterling / Euro exchange rate is set to 1:1, the construction and lifetime cost estimates vary by between zero and about 25%, as might be expected. That said, none of the three options came close to changing their positions in the table of rankings by cost.



Table 8-31 – Costs Overview - Sterling / Euro exchange rate at 1:1

Whole Route - (£1 Sterling = 1 Euro)					
AC OHL and AC UGC				AC OHL and DC UGC	
<b>Construction Costs + IDC</b>				<b>Construction Costs + IDC</b>	
	€M	£M		€M	£M
HVAC OHL	81	81		HVAC OHL	81
HVAC UGC	548	548		HVDC UGC	672
Difference	467	467		Difference	591
Difference (times)	6.8			Difference (times)	8.3
<b>Lifetime Running Costs</b>				<b>Lifetime Running Costs</b>	
	€M	£M		€M	£M
HVAC OHL	44	44		HVAC OHL	44
HVAC UGC	72	72		HVDC UGC	104
Difference	28	28		Difference	60
Difference (times)	1.6			Difference (times)	2.4
<b>40-year Replacement Cost</b>				<b>40-year Replacement Cost</b>	
	€M	£M		€M	£M
HVAC OHL	5	5		HVAC OHL	5
HVAC UGC	32	32		HVDC UGC	39
Difference	27	27		Difference	34
Difference (times)	6.8			Difference (times)	8.3
<b>Overall Whole-of-Life Costs</b>				<b>Overall Whole-of-Life Costs</b>	
	€M	£M		€M	£M
HVAC OHL	129	129		HVAC OHL	129
HVAC UGC	652	652		HVDC UGC	814
Difference	523	523		Difference	685
Difference (times)	5.0			Difference (times)	6.3

Note: Totals subject to rounding error

## 8.8 Sensitivity of comparisons to HVDC cost assumptions

491. The discussion in Section 8.5 indicated reasons for additional levels of uncertainty surrounding the HVDC cost estimates. To test the sensitivity of the costing comparisons to the HVDC costing assumptions, therefore, the comparison

calculations for the overall route were repeated with a notional 25% discount on the HVDC costs. The results are provided in Table 8-32.

**Table 8-32 – Costs Overview - Sensitivity to HVDC cost estimates**

<b>Whole Route - (with 25% discount on HVDC Costs)</b>						
<b>AC OHL and AC UGC</b>				<b>AC OHL and DC UGC</b>		
<b>Construction Costs + IDC</b>				<b>Construction Costs + IDC</b>		
	€M	£M		€M	£M	
HVAC OHL	81	65		HVAC OHL	81	65
HVAC UGC	588	470		HVDC UGC	504	403
Difference	507	405		Difference	423	338
Difference (times)	7.3			Difference (times)	6.2	
<b>Lifetime Running Costs</b>				<b>Lifetime Running Costs</b>		
	€M	£M		€M	£M	
HVAC OHL	44	35		HVAC OHL	44	35
HVAC UGC	73	58		HVDC UGC	78	62
Difference	29	23		Difference	34	27
Difference (times)	1.7			Difference (times)	1.8	
<b>40-year Replacement Cost</b>				<b>40-year Replacement Cost</b>		
	€M	£M		€M	£M	
HVAC OHL	5	4		HVAC OHL	5	4
HVAC UGC	34	27		HVDC UGC	29	23
Difference	30	24		Difference	25	20
Difference (times)	7.3			Difference (times)	6.2	
<b>Overall Whole-of-Life Costs</b>				<b>Overall Whole-of-Life Costs</b>		
	€M	£M		€M	£M	
HVAC OHL	129	103		HVAC OHL	129	103
HVAC UGC	695	556		HVDC UGC	611	488
Difference	565	452		Difference	481	385
Difference (times)	5.4			Difference (times)	4.7	

Note: Totals subject to rounding error

492. It may be seen from this table that with a 25% reduction on the HVDC cost estimate, the HVDC solution would still be several times the cost of the proposed OHL to build,

and a little under twice the cost to run throughout its life. However, it would move its overall whole-of-life cost rank position from third to second, since its construction costs would be significantly less than those for UGC.

## 8.9 Conclusion for Costs

493. The cost estimates in this study concentrate upon the differences between the use of OHL and UGC. Some common costs, such as terminating switchgear and landowner compensation are not included here.
494. The landscape patterns identified by the landscape architect who visited the UGC route search corridor for this Project were found to be a very useful basis upon which to estimate the costs associated with each section of the route. At this strategic level, however, unit costs for some of the identified patterns could be banded together. Only three categories of landscape were required for the civil engineering estimates – two trenching categories and a horizontal directional drilling category. For the electrical equipment supply and installation cost estimates two main categories were used.
495. In the opinion of the specialist cable design and transmission engineers who visited the UGC route search corridor, the circuit lengths assumed by this study are the minimum likely to be found within the search corridor identified for this Project whilst avoiding designated areas. Land negotiations and other factors may increase the practical route length of any OHL or UGC circuit, however it is considered that the lengths adopted here afford appropriate comparison between OHL and UGC.
496. Moderate horizontal directional drilling cost estimates have been used in this study. However, they represent a considerable source of uncertainty for the UGC costings at present since no detailed ground borehole survey has been carried out. For this reason practical costs for an UGC may rise above those assumed here.
497. It is estimated that the overall construction cost of HVAC OHL for the whole Meath – Cavan – Tyrone route would be €81M. In comparison, it is estimated that the overall construction cost of HVAC UGC for the whole route would be €588M. This represents an additional cost to complete the Project with UGC of €507M, or more than seven times the OHL estimate.
498. Given an expected average transfer across the circuit of 500 MVA and a maximum transfer (under normal operating conditions) of 750 MVA, it is estimated that the 40 year lifetime running costs of HVAC OHL over the whole Meath – Cavan – Tyrone route would be €44M. In comparison, it is estimated that the lifetime running costs of HVAC UGC over the whole route would be €73M. This represents an additional lifetime running cost for the Project with UGC of €29M, or a little over one and a half times that for OHL.
499. Similarly, for HVDC, it is estimated that the overall construction cost of HVDC links between Co. Meath and Co. Cavan and between Co. Cavan and Co. Tyrone, using LCC converter stations and HVDC UGC would be €672M. This represents an additional cost to complete the Project with HVDC UGC of €591M, or more than eight

times the OHL estimate. (Strategic spares could represent a considerable additional capital cost to an HVDC solution.)

500. Again, given an expected average transfer across the circuit of 500 MVA and a maximum transfer (under normal operating conditions) of 750 MVA, it is estimated that the 40 year lifetime running costs of these HVDC links over the whole Meath – Cavan – Tyrone route would be €104M. This represents an additional lifetime running cost for the Project with HVDC of €60M, or well over twice that for OHL.
501. Estimated present value end-of-life replacement costs for HVAC OHL, HVAC UGC, and HVDC UGC are €5M, €34M and €39M respectively. Summing construction, running and end-of-life replacement costs, the ranking, by cost, of the transmission options for this Project is thus:-

Rank	Technology	Whole route overall whole-of-life costs (€M)
1	HVAC OHL	129
2	HVAC UGC	695
3	HVDC UGC	814

Note: Totals subject to rounding error

502. This whole-route cost ranking order is also applicable to the individual Meath – Cavan and Cavan – Tyrone circuits.
503. The sensitivity of this ranking order to the HVDC cost estimates is such that, a 25% reduction in the HVDC overall costs would move it into second place, above HVAC UGC.
504. Variations in the Sterling / Euro exchange rate seen over recent months make some changes to the estimated costs, but do not modify the cost ranking order of the transmission options.
505. HVAC UGC cost estimates in this study have been based upon a cable design with an aluminium core of 1200mm<sup>2</sup>. If 1600mm<sup>2</sup> cable were installed in place of the 1200mm<sup>2</sup> option, construction costs would be increased by about 1.5% whilst lifetime running costs would be somewhat lower.

## 9. CONCLUSIONS - COMPARISON OF TRANSMISSION OPTIONS

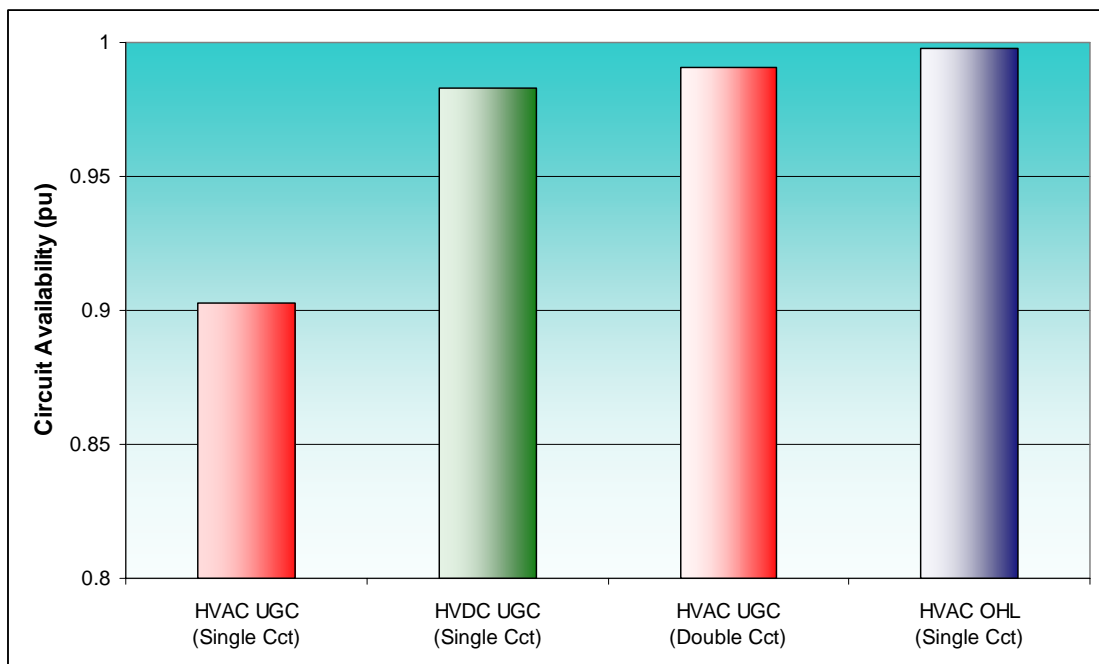
### 9.1 Technical summary

#### 9.1.1 HVAC

506. Over 98% of the onshore extra high voltage electricity transmission network in Europe (European Union, Norway and Switzerland) is of HVAC overhead line construction. Underground cable is mainly applied in urban or environmentally sensitive areas.
507. HVAC overhead line transmission is most common, primarily because it represents the lowest cost technically feasible approach to establishing and maintaining a secure electrical power grid. Global transmission development activity suggests that this preference by utilities for the use of overhead line is likely to persist into the future.
508. Although a number of countries have been actively considering the use of UGC in their transmission systems, the rate at which transmission networks are being undergrounded is very low.
509. There is a limit to the world production capacity for HVAC XLPE cables. If it was decided to underground the connections for the whole Meath – Cavan – Tyrone route, XLPE cable manufacture and installation would be likely to take 3 to 4 years even assuming supply from 2 or 3 reliable sources was available.
510. Since the longest XLPE transmission cable circuit installed to date runs for some 40 km, and most are less than 20 km long, a 140 km installation would comprise a “world first”.
511. The power transmission requirement for the Project is 1500MVA, so two cables per phase would be required to meet the rating, each aluminium cable carrying half of the phase loading.
512. Two cores per phase could offer the benefits, for a relatively small additional cost, of two electrically separate circuits. However, costing estimates here assume the least-cost solution of one circuit with two cores per phase.
513. OHL operational losses would be lower than 2-core 1200mm<sup>2</sup> aluminium UGC losses for average circuit transfers below about 900 MVA. For average circuit transfers above this, UGC losses would be lower than those of the OHL losses. Adoption of a somewhat more expensive 1600mm<sup>2</sup> aluminium UGC design would lower this cross-over point to around 840 MVA. Thus, with the expected average transfer of 500 MVA, it is likely that the overall lifetime losses on the circuit would be lower if constructed with OHL rather than with UGC.
514. The cable construction working swathe would be some 20 – 22 m wide along the length of the route. An operational swathe of similar width would need to be kept clear of tree growth, buildings or significant earthworks.

- 515. Regarding construction schedule, technically and organisationally, an OHL solution could be delivered quicker (2 to 3 years) than an UGC solution (at least 3 to 4 years). Land owner access consent, which is likely to be an issue for either approach, is beyond the scope of this report.
- 516. Regarding performance in service, OHL are susceptible to environmental effects and thus normally exhibit fault rates higher than those of cable circuits. However, average repair times of UGC are much higher than those of OHL, being measured in weeks rather than hours. This causes the long-term availability of OHL to be significantly higher than that of UGC.
- 517. Transmission system security all over Europe relies upon the relatively high availabilities that are provided by OHL networks. A comparison of the whole route HVAC and HVDC circuit availabilities from Sections 4 and 6 (see Table 4-2 and Table 6-1) is provided in Figure 9-1. Of the options considered, single circuit HVAC UGC performs least well, single circuit HVAC OHL performs best. HVDC and double circuit HVAC UGC lie between these.
- 518. Thus it may be seen that the introduction of significant quantities of UGC in strategic transmission routes may well compromise system security. Cable availabilities would need to improve by more than twice for the double circuit UGC to match the OHL performance, and by more than 50 times for the single circuit UGC to match OHL.

**Figure 9-1 – Circuit Availability – Alternative Technologies (per unit)**



- 519. Significant reactive compensation would be required for the Project if an UGC solution was to be chosen. Many alternative designs are practicable, but the assumptions of this report allow for relatively small compensator installations at each of the three substations and at three intermediate locations along the 140 km route. This approach would facilitate transport into locations remote from major roads and

would tend to reduce the cost of cable insulation. In addition, it would simplify any strategic spares strategy for this important part of the installation.

- 520. The additional capacitance added to any system by UGC would have the effect of lowering the frequencies at which the system resonates, which may increase the Project costs.
- 521. UGC, particularly long installations, can have a negative impact upon system complexity.
- 522. OHL is seen to be much more flexible over the long term than UGC.

### **9.1.2 HVDC**

- 523. Successful application HVDC transmission within a meshed all-island network would depend upon a considerable amount of HVAC equipment and a sizeable converter station installation at each of its connecting points to the HVAC network
- 524. Complex control algorithms would be required to allow it to respond appropriately to the conditions of the existing AC network. For this, and other reasons, an HVDC solution would introduce more system complexity than an HVAC OHL.
- 525. HVDC terminal stations would require more planned maintenance outages than their HVAC equivalents. In addition to any equipment failures, system operators would need to plan for around 18 days each year when the HVDC bipole link would be running at 50% capacity, and around a further 2 days each year when it would not operate.
- 526. The proposed Project would double the Northern Ireland - Republic of Ireland interconnector capacity so, during any period when the Project connection is out of service, the available interconnector transfer capacity would be halved. In this circumstance the significant annual maintenance periods of HVDC would represent an operational disadvantage.
- 527. A new and substantial strategic spares holding of HVDC equipment would need to be established to maintain the quoted availability.
- 528. For these technical reasons HVDC is not recommended over the proposed OHL connection.

## **9.2 Environment**

### **9.2.1 Terrain appraisal and Strategic UGC Route Search Corridor**

- 529. Routing criteria for establishing UGC strategic routing corridors have been developed to accommodate the landscape characteristics of the terrain over the whole route.
- 530. A continuous, technically feasible, strategic UGC route search corridor for the Project that satisfied these routing criteria has been identified.

531. The search corridor passes principally through agricultural land, and avoids routeing constraints presented by identified natural, cultural heritage, and landscape features. Though Landscape Type 2b presents probably the most challenging of the terrain types, even these areas are not prohibitive to the installation of UGC using the direct-buried technique.
532. The identified underground cable route search corridor avoids crossing any area “designated” for landscape purposes.
533. Landscape patterns were found to be a useful approach to managing routeing considerations, assessing UGC route options and estimating drum lengths, and thus estimating civil and overall undergrounding costs.
534. Underground cables have the capacity to inflict considerable short-term (construction period) and long-term operational negative impact on the environment. This impact would be best mitigated through a combination of careful route selection and a comprehensive programme of land and facility reinstatement following the construction works, avoiding altogether designated areas if possible.

### 9.2.2 EMFs

535. OHL produces power frequency electric fields which are relatively stable in time. The proposed OHL would produce a maximum field strength of around 8.3 kV/m, which is lower than the European and Irish adopted ICNIRP Basic Restriction guideline limit of 9 kV/m. The field strength would drop to about one tenth of its maximum at about 35 m from the centreline of the OHL.
536. Both OHL and UGC produce power frequency magnetic fields whose strengths would be directly proportional to the electrical load being carried at any instant. The magnetic fields from the OHL and the UGC would have maximum strengths (at full load) of around 48 $\mu$ T and 68 $\mu$ T respectively. These are both much lower than the European and Irish adopted ICNIRP Basic Restriction guideline limit of 360 $\mu$ T.
537. Under normal circumstances the peak magnetic field strengths to be found near the circuit would be much lower than these maxima, since the circuit would only run at full load under emergency conditions. Moving away from the centreline of the circuit, the OHL and UGC field strengths would have dropped to one tenth of their values at around 45 m and 8 m respectively.

### 9.3 Construction and lifetime running costs

538. The cost estimates in this study concentrate upon the differences between the use of OHL and UGC. Some common costs, such as terminating switchgear and landowner compensation are not included here.
539. The landscape patterns identified by the landscape architect who visited the UGC route search corridor for this Project were found to be a very useful basis upon which to estimate the costs associated with each section of the route. At this strategic level, however, unit costs for some of the identified patterns could be banded together. Only three categories of landscape were required for the civil engineering estimates –



- two trenching categories and a horizontal directional drilling category. For the electrical equipment supply and installation cost estimates two main categories were used.
540. In the opinion of the specialist cable design and transmission engineers who visited the UGC route search corridor, the circuit lengths assumed by this study are the minimum likely to be found within the search corridor identified for this Project whilst avoiding designated areas. Land negotiations and other factors may increase the practical route length of any OHL or UGC circuit, however it is considered that the lengths adopted here afford appropriate comparison between OHL and UGC.
541. Moderate horizontal directional drilling cost estimates have been used in this study, but they represent a considerable source of uncertainty for the UGC costings at present since no detailed ground borehole survey has been carried out. For this reason practical costs for an UGC may rise above those stated here.
542. It is estimated that the overall construction cost of HVAC OHL for the whole Meath – Cavan – Tyrone route would be €81M. In comparison, it is estimated that the overall construction cost of HVAC UGC for the whole route would be €588M. This represents an additional cost to complete the Project with UGC of €507M, or more than seven times the OHL estimate.
543. Given an expected average transfer across the circuit of 500 MVA and a maximum transfer (under normal operating conditions) of 750 MVA, it is estimated that the 40 year lifetime running costs of HVAC OHL over the whole Meath – Cavan – Tyrone route would be €44M. In comparison, it is estimated that the lifetime running costs of HVAC UGC over the whole route would be €73M. This represents an additional lifetime running cost for the Project with UGC of €29M, or a little over one and a half times that for OHL.
544. Similarly, for HVDC, it is estimated that the overall construction cost of HVDC links between Co. Meath and Co. Cavan and between Co. Cavan and Co. Tyrone, using LCC converter stations and HVDC UGC would be €672M. This represents an additional cost to complete the Project with HVDC UGC of €591M, or more than eight times the OHL estimate. (Strategic spares could represent a considerable additional capital cost to an HVDC solution.)
545. Again, given an expected average transfer across the circuit of 500 MVA and a maximum transfer (under normal operating conditions) of 750 MVA, it is estimated that the 40 year lifetime running costs of these HVDC links over the whole Meath – Cavan – Tyrone route would be €104M. This represents an additional lifetime running cost for the Project with HVDC of €60M, or well over twice that for OHL.
546. Estimated present value end-of-life replacement costs for HVAC OHL, HVAC UGC, and HVDC UGC are €5M, €34M and €39M respectively. Summing construction, running and end-of-life replacement costs, the ranking, by cost, of the transmission options for this Project is thus:-

Rank	Technology	Whole route overall whole-of-life costs (€M)
1	HVAC OHL	129
2	HVAC UGC	695
3	HVDC UGC	814

Note: Totals subject to rounding error

547. This whole-route cost ranking order is also applicable to the individual Meath – Cavan and Cavan – Tyrone circuits.
548. Variations in the exchange rate seen over recent months make some changes to the estimated costs, but do not modify the cost ranking order of the transmission options.

#### 9.4 Overall Conclusions

549. Overhead line and underground cable connections between Meath and Cavan, and between Cavan and Tyrone, are both technically and environmentally feasible.
550. These circuits could each be effected by using either HVAC or HVDC.
551. The most cost effective solution would be to use overhead HVAC, estimated to cost around €81M to construct and a further €44M lifetime running costs.
552. An HVAC underground cable would cost over 7 times as much as HVAC OHL to construct, and would then be more than 1.5 times as much as OHL to run over its lifetime.
553. Similarly, HVDC UGC links would cost over 8 times as much as HVAC OHL to construct, and would then be more than twice as much as HVAC OHL to run over its lifetime.

## **APPENDIX 1 - UNIT COST FACTORS**



## Overhead Line unit cost factors taken into account by PB Power estimates

### Design Factors

- Conductors per bundle
- Wind span and span utilisation
- Surveying
- Access roads
- Foundations
- Proportion of towers requiring temporary access roads
- Tower delivery and construction
- Insulator delivery and installation
- % Suspension towers
- % piled tower foundations
- Conductor Fittings
- Conductors and OPGW earth-wire delivery and stringing

### External Factors

- Aluminium Price/kg
- Steel Price/kg
- Transport weights
- Tower Earthing
- Labour costs
- Engineering costs

### Other

- Price adjustment for line length

### Underground cable unit cost factors taken into account by PB Power estimates

Category	Description	Unit
Fixed		
	Mobilise & Demob	Lot
	Testing/Commissioning	per 20km
Per Trench km		
	Material Handling and Inspection	per km
	Supply Power Cable 6 off	per km
	Supply Auxiliary & DTS (Cable & ducts)	per km
	Supply Civils (CBS, Tiles, tape)	per km
	Design, QA and Safety Services	per km
Per Joint Bay		
	Supply Power Cable Joints	per bay
	Supply Bonding and earthing	per bay
	Supply Civils Steelwork and Cleats	per bay
Per Termination		
	Supply Power Cable Terminations 6 off	per compound
	Supply Bonding and Earthing	per compound
	Supply Civils (Support Structures)	per compound
Electrical Installation		
	Joint Bay and Joint 6 cables	per bay
	Termination	per compound

**APPENDIX 2 - SUMMARY COMPARISON SPECIFIC TO CO. MEATH – CO. CAVAN  
(EIRGRID) SECTION**





**SUMMARY COSTS SPECIFIC TO CO. MEATH – CO. CAVAN (EIRGRID)**

Summary Comparison - Euros Table		Col 1	Col 2	Col 3	Col 4	Col 5	Col 6	Col 7
Line No.	Item	AC OHL	AC UGC	LCC DC UGC	AC OHL - AC UGC differences	AC OHL - DC UGC differences	AC OHL-UGC difference factor	AC OHL-DC UGC difference factor
1	Route	M-C EirGrid	M-C EirGrid	M-C EirGrid	M-C EirGrid	M-C EirGrid	M-C EirGrid	M-C EirGrid
2	Route Length (km)	53	55	55	2	2	1.0	1.0
3	Total Route Construction Cost (€M)	32	230	265	197	233	7.1	8.2
4	of which, Reactive Compensation Cost (€M)	0	20	not separately costed	20	n/a	-	n/a
5	of which, Special Civils Cost (€M)	0	20	not separately costed	20	n/a	-	n/a
6	<b>Whole Life Cost, including Construction, IDC, lifetime energy losses costs, annualised power losses and 40 year replacement (€M, rounded)</b>	<b>53</b>	<b>281</b>	<b>333</b>	<b>228</b>	<b>280</b>	<b>5.3</b>	<b>6.2</b>
	Comprising:							
7	1. PV of Construction Costs +IDC (€M)	33	238	275	205	242	7.1	8.2
8	Construction Costs as %	58%	79%	77%				
9	2. PV of Maintenance and Losses Costs (€M)	18	29	42	11	24	1.6	2.3
10	O&M and Losses Costs as %	34%	10%	13%				
11	3. PV of 40 year replacement Costs (€M)	2	14	16	12	14	7.1	8.2
12	40 year replacement Costs as %	8%	11%	11%				

**SUMMARY COSTS SPECIFIC TO CO. MEATH – CO. CAVAN (EIRGRID) SECTION**

Summary Comparison - Sterling Table		Col 1	Col 2	Col 3	Col 4	Col 5	Col 6	Col 7
Line No.	Item	AC OHL	AC UGC	LCC DC UGC	AC OHL - AC UGC differences	AC OHL - DC UGC differences	AC OHL-UGC difference factor	AC OHL-DC UGC difference factor
1	Route	M-C EirGrid	M-C EirGrid	M-C EirGrid	M-C EirGrid	M-C EirGrid	M-C EirGrid	M-C EirGrid
2	Route Length (km)	53	55	55	2	2	1.0	1.0
3	Total Route Construction Cost (£M)	26	184	212	158	186	7.1	8.2
4	of which, Reactive Compensation Cost (£M)	0	16	not separately costed	16	n/a	-	n/a
5	of which, Special Civils Cost (£M)	0	16	not separately costed	16	n/a	-	n/a
6	<b>Whole Life Cost, including Construction, IDC, lifetime energy losses costs, annualised power losses and 40 year replacement (£M, rounded)</b>	<b>43</b>	<b>225</b>	<b>267</b>	<b>182</b>	<b>224</b>	<b>5.3</b>	<b>6.2</b>
	Comprising:							
7	1. PV of Construction Costs and IDC (£M)	27	190	220	164	193	7.1	8.2
8	Construction Costs as %	58%	79%	77%				
9	2. PV of Maintenance and Losses Costs (£M)	14	24	34	9	19	1.6	2.3
10	O&M and Losses Costs as %	34%	10%	13%				
11	3. PV of 40 year replacement Costs (£M)	2	11	13	10	11	7.1	8.2
12	40 year replacement Costs as %	8%	11%	11%				

**APPENDIX 3 - SUMMARY COMPARISON SPECIFIC TO CO. CAVAN – CO. TYRONE  
(EIRGRID) SECTION**



**SUMMARY COSTS SPECIFIC TO CO. CAVAN – CO. TYRONE (EIRGRID) SECTION**

Summary Comparison - Euros Table		Col 1	Col 2	Col 3	Col 4	Col 5	Col 6	Col 7
Line No.	Item	AC OHL	AC UGC	LCC DC UGC	AC OHL - AC UGC differences	AC OHL - DC UGC differences	AC OHL-UGC difference factor	AC OHL-DC UGC difference factor
1	Route	C-T EirGrid	C-T EirGrid	C-T EirGrid	C-T EirGrid	C-T EirGrid	C-T EirGrid	C-T EirGrid
2	Route Length (km)	45	48	48	3	3	1.1	1.1
3	Total Route Construction Cost (€M)	27	202	229	175	202	7.4	8.4
4	of which, Reactive Compensation Cost (€M)	0	20	not separately costed	20	n/a	-	n/a
5	of which, Special Civils Cost (€M)	0	14	not separately costed	14	n/a	-	n/a
6	<b>Whole Life Cost, including Construction, IDC, lifetime energy losses costs, annualised power losses and 40 year replacement (€M, rounded)</b>	<b>45</b>	<b>247</b>	<b>288</b>	<b>202</b>	<b>242</b>	<b>5.5</b>	<b>6.4</b>
	Comprising:							
7	1. PV of Construction Costs +IDC (€M)	28	209	237	181	209	7.4	8.4
8	Construction Costs as %	58%	79%	77%				
9	2. PV of Maintenance and Losses Costs (€M)	15	26	37	10	21	1.7	2.4
10	O&M and Losses Costs as %	34%	10%	13%				
11	3. PV of 40 year replacement Costs (€M)	2	12	14	11	12	7.4	8.4
12	40 year replacement Costs as %	8%	11%	11%				

**SUMMARY COSTS SPECIFIC TO CO. CAVAN – CO. TYRONE (EIRGRID) SECTION**

Summary Comparison - Sterling Table		Col 1	Col 2	Col 3	Col 4	Col 5	Col 6	Col 7
Line No.	Item	AC OHL	AC UGC	LCC DC UGC	AC OHL - AC UGC differences	AC OHL - DC UGC differences	AC OHL-UGC difference factor	AC OHL-DC UGC difference factor
1	Route	C-T EirGrid	C-T EirGrid	C-T EirGrid	C-T EirGrid	C-T EirGrid	C-T EirGrid	C-T EirGrid
2	Route Length (km)	45	48	48	3	3	1.1	1.1
3	Total Route Construction Cost (£M)	22	161	183	140	161	7.4	8.4
4	of which, Reactive Compensation Cost (£M)	0	16	not separately costed	16	n/a	-	n/a
5	of which, Special Civils Cost (£M)	0	11	not separately costed	11	n/a	-	n/a
6	<b>Whole Life Cost, including Construction, IDC, lifetime energy losses costs, annualised power losses and 40 year replacement (£M, rounded)</b>	<b>36</b>	<b>198</b>	<b>230</b>	<b>162</b>	<b>194</b>	<b>5.5</b>	<b>6.4</b>
	Comprising:							
7	1. PV of Construction Costs and IDC (£M)	23	167	190	145	167	7.4	8.4
8	Construction Costs as %	58%	79%	77%				
9	2. PV of Maintenance and Losses Costs (£M)	12	20	29	8	17	1.7	2.4
10	O&M and Losses Costs as %	34%	10%	13%				
11	3. PV of 40 year replacement Costs (£M)	1	10	11	8	10	7.4	8.4
12	40 year replacement Costs as %	8%	11%	11%				

**APPENDIX 4 - SUMMARY COMPARISON SPECIFIC TO CO. CAVAN – CO. TYRONE  
(NIE) SECTION**





**SUMMARY COMPARISON SPECIFIC TO CO. CAVAN – CO. TYRONE (NIE) SECTION**

Summary Comparison - Euros Table		Col 1	Col 2	Col 3	Col 4	Col 5	Col 6	Col 7
Line No.	Item	AC OHL	AC UGC	LCC DC UGC	AC OHL - AC UGC differences	AC OHL - DC UGC differences	AC OHL-UGC difference factor	AC OHL-DC UGC difference factor
1	Route	C-T NIE	C-T NIE	C-T NIE	C-T NIE	C-T NIE	C-T NIE	C-T NIE
2	Route Length (km)	31	32	32	1	1	1.0	1.0
3	Total Route Construction Cost (€M)	19	136	154	117	135	7.3	8.2
4	of which, Reactive Compensation Cost (€M)	0	20	not separately costed	20	n/a	-	n/a
5	of which, Special Civils Cost (€M)	0	11	not separately costed	11	n/a	-	n/a
6	<b>Whole Life Cost, including Construction, IDC, lifetime energy losses costs, annualised power losses and 40 year replacement (€M, rounded)</b>	<b>31</b>	<b>166</b>	<b>193</b>	<b>135</b>	<b>162</b>	<b>5.4</b>	<b>6.2</b>
	Comprising:							
7	1. PV of Construction Costs +IDC (€M)	19	141	159	121	140	7.3	8.2
8	Construction Costs as %	58%	79%	77%				
9	2. PV of Maintenance and Losses Costs (€M)	10	18	25	7	14	1.7	2.3
10	O&M and Losses Costs as %	34%	11%	13%				
11	3. PV of 40 year replacement Costs (€M)	1	8	9	7	8	7.3	8.2
12	40 year replacement Costs as %	8%	11%	11%				

## SUMMARY COMPARISON SPECIFIC TO CO. CAVAN – CO. TYRONE (NIE) SECTION

Summary Comparison - Sterling Table		Col 1	Col 2	Col 3	Col 4	Col 5	Col 6	Col 7
Line No.	Item	AC OHL	AC UGC	LCC DC UGC	AC OHL - AC UGC differences	AC OHL - DC UGC differences	AC OHL-UGC difference factor	AC OHL-DC UGC difference factor
1	Route	C-T NIE	C-T NIE	C-T NIE	C-T NIE	C-T NIE	C-T NIE	C-T NIE
2	Route Length (km)	31	32	32	1	1	1.0	1.0
3	Total Route Construction Cost (£M)	15	108	123	93	108	7.3	8.2
4	of which, Reactive Compensation Cost (£M)	0	16	not separately costed	16	n/a	-	n/a
5	of which, Special Civils Cost (£M)	0	9	not separately costed	9	n/a	-	n/a
6	<b>Whole Life Cost, including Construction, IDC, lifetime energy losses costs, annualised power losses and 40 year replacement (£M, rounded)</b>	<b>25</b>	<b>133</b>	<b>155</b>	<b>108</b>	<b>130</b>	<b>5.4</b>	<b>6.2</b>
	Comprising:							
7	1. PV of Construction Costs and IDC (£M)	15	112	127	97	112	7.3	8.2
8	Construction Costs as %	58%	79%	77%				
9	2. PV of Maintenance and Losses Costs (£M)	8	14	20	6	11	1.7	2.3
10	O&M and Losses Costs as %	34%	11%	13%				
11	3. PV of 40 year replacement Costs (£M)	1	7	7	6	7	7.3	8.2
12	40 year replacement Costs as %	8%	11%	11%				

**APPENDIX 5 - SUMMARY COSTS FOR THE OVERALL CO. MEATH - CO. CAVAN –  
CO. TYRONE (NIE AND EIRGRID) ROUTE**

**OVERALL ROUTE SUMMARY COMPARISON MEATH – CO. CAVAN – CO. TYRONE (NIE AND EIRGRID)**

Summary Comparison - Euros Table		Col 1	Col 2	Col 3	Col 4	Col 5	Col 6	Col 7
Line No.	Item	AC OHL	AC UGC	LCC DC UGC	AC OHL - AC UGC differences	AC OHL - DC UGC differences	AC OHL-UGC difference factor	AC OHL-DC UGC difference factor
1	Route	Whole Route	Whole Route	Whole Route	Whole Route	Whole Route	Whole Route	Whole Route
2	Route Length (km)	128	135	135	7	7	1.1	1.1
3	Total Route Construction Cost (€M)	78	567	648	489	570	7.3	8.3
4	of which, Reactive Compensation Cost (€M)	0	61	not separately costed	61	n/a	-	n/a
5	of which, Special Civils Cost (€M)	0	45	not separately costed	45	n/a	-	n/a
6	<b>Whole Life Cost, including Construction, IDC, lifetime energy losses costs, annualised power losses and 40 year replacement (€M, rounded)</b>	<b>129</b>	<b>695</b>	<b>814</b>	<b>565</b>	<b>685</b>	<b>5.4</b>	<b>6.3</b>
	Comprising:							
7	1. PV of Construction Costs +IDC (€M)	81	588	672	507	591	7.3	8.3
8	Construction Costs as %	58%	79%	77%				
9	2. PV of Maintenance and Losses Costs (€M)	44	73	104	29	60	1.7	2.4
10	O&M and Losses Costs as %	34%	10%	13%				
11	3. PV of 40 year replacement Costs (€M)	5	34	39	30	34	7.3	8.3
12	40 year replacement Costs as %	8%	11%	11%				

**OVERALL ROUTE SUMMARY COMPARISON MEATH – CO. CAVAN – CO. TYRONE (NIE AND EIRGRID)**

Summary Comparison - Sterling Table		Col 1	Col 2	Col 3	Col 4	Col 5	Col 6	Col 7
Line No.	Item	AC OHL	AC UGC	LCC DC UGC	AC OHL - AC UGC differences	AC OHL - DC UGC differences	AC OHL-UGC difference factor	AC OHL-DC UGC difference factor
1	Route	Whole Route	Whole Route	Whole Route	Whole Route	Whole Route	Whole Route	Whole Route
2	Route Length (km)	128	135	135	7	7	1.1	1.1
3	Total Route Construction Cost (£M)	62	453	518	391	456	7.3	8.3
4	of which, Reactive Compensation Cost (£M)	0	49	not separately costed	49	n/a	-	n/a
5	of which, Special Civils Cost (£M)	0	36	not separately costed	36	n/a	-	n/a
6	<b>Whole Life Cost, including Construction, IDC, lifetime energy losses costs, annualised power losses and 40 year replacement (£M, rounded)</b>	<b>103</b>	<b>556</b>	<b>651</b>	<b>452</b>	<b>548</b>	<b>5.4</b>	<b>6.3</b>
7	Comprising:							
8	1. PV of Construction Costs and IDC (£M)	65	470	537	405	472	7.3	8.3
9	Construction Costs as %	58%	79%	77%				
10	2. PV of Maintenance and Losses Costs (£M)	35	58	83	23	48	1.7	2.4
11	O&M and Losses Costs as %	34%	10%	13%				
12	3. PV of 40 year replacement Costs (£M)	4	27	31	24	27	7.3	8.3
13	40 year replacement Costs as %	8%	11%	11%				

**APPENDIX 6 - EXTRA HIGH VOLTAGE XLPE UNDERGROUND CABLE**



## APPENDIX 6 CONTENTS

### 1 EHV XLPE Cable

- 1.1 Conductors
- 1.2 Conductor Screen
- 1.3 Insulation
- 1.4 Insulation Screen
- 1.5 Metallic Barrier
- 1.6 Oversheath
- 1.7 Bending Performance
- 1.8 Cable System Accessories
- 1.9 Joints
- 1.10 Terminations
- 1.11 Earthing And Bonding Equipment

### 2 Construction

- 2.1 Site Accommodation And Storage
- 2.2 Enabling Works
- 2.3 Cable And Circuit Spacings
- 2.4 Swathe Preparation
- 2.5 Excavation Of And Backfilling Of Ducted Trenches
- 2.6 Excavation and backfilling of ducted trenches
- 2.7 Cable Installation For Direct Buried Installation
- 2.8 Jointing
- 2.9 Jointing Terminations
- 2.10 Swathe Reinstatement
- 2.11 Buildings Over The Cables
- 2.12 Maintenance And Life Expectancy Of Cable



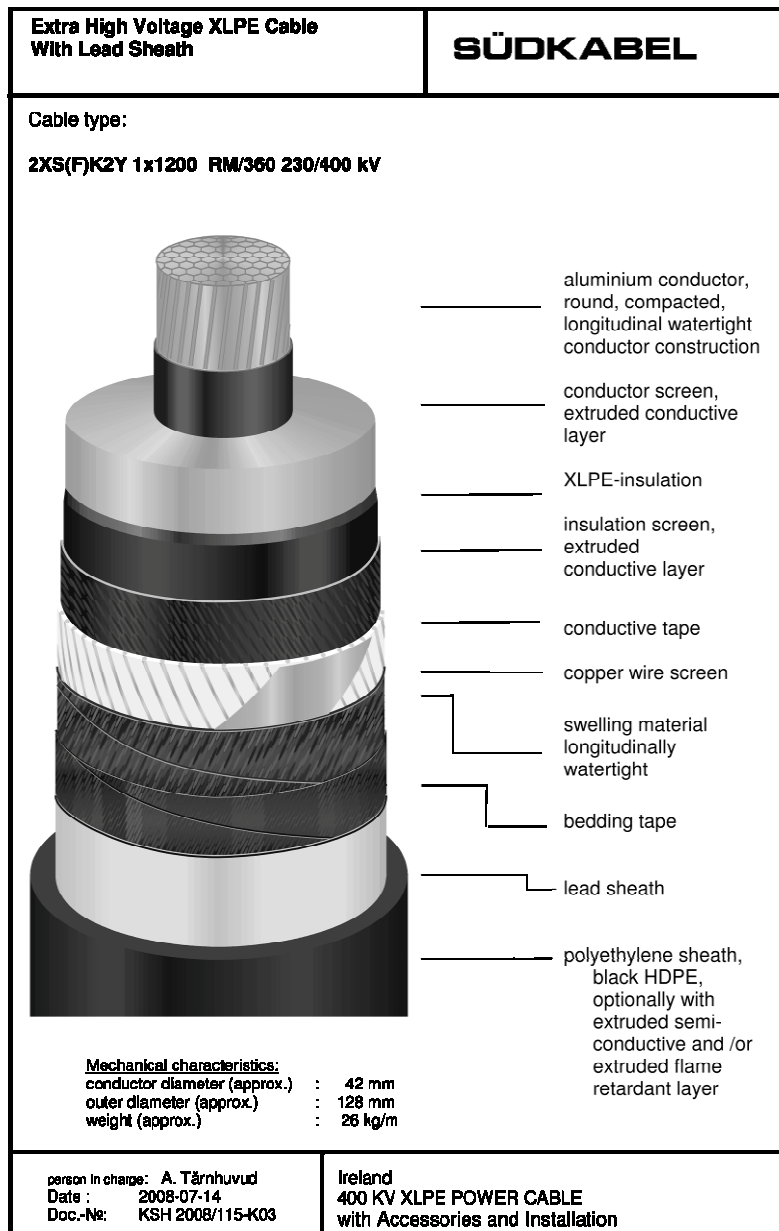
## **1 EHV XLPE CABLE**

- 1) In the past the dominant extra high voltage (EHV) cable designs have been low pressure oil filled cables (also known as fluid filled cables) which have a paper or paper and polypropylene laminate insulation. 400kV oil filled cables have been available for over 50 years. There are records of an installation in Sweden in 1952. There is a 400kV oil filled cable installed at Moneypoint Power Station in the Republic of Ireland in the 1980's. However, oil filled (also called fluid filled) cables are becoming obsolete and new installations are using more recent cross-linked polyethylene (XLPE) insulated cable designs. It is thus recommended that if any underground cable sections are to be used on the Woodland - Kingscourt - Turleenan connection, then XLPE insulated cables should be employed.
- 2) Figure 1 illustrates a 400kV aluminium conductor XLPE cable and its constituent components and features.
- 3) The design of a cable system will have been the subject of long term reliability testing before being adopted by a utility for its strategic circuits.

### **1.1 Conductors**

- 4) Directly buried cable circuits do not receive the benefit of air cooling and in order to meet the current rating requirement for both the Woodland - Kingscourt and Kingscourt - Turleenan connection (1500MVA through all seasons) the cables require a larger size of conductor than an equivalent overhead line.
- 5) Being mostly underground, there is little chance of the conductors being struck by lightning however lightning impulses can be transferred to cables via connections to air insulated switchgear (AIS) or overhead line (OHL).

Figure 1 400kV XLPE Insulated Cable (courtesy Südkabel GmbH)



- 6) There is a requirement for one or more earth conductors to ensure that an adequate return path for fault currents is provided. These conductors may be integrated into the cable design or where necessary, for example when using end point bonded systems, supplied as a separate earth continuity conductor (ECC).
  
- 7) EHV cable transmission conductors are made from either copper or aluminium. Copper has a lower electrical resistance than aluminium and thus is capable of carrying a higher current. The permissible alternating current carrying capacity of large copper conductors may be further increased by coating the conductor strands with an insulating layer, normally copper oxide or enamel. The choice of conductor is also determined by the magnitude of the power transmission requirement and the price of copper compared to aluminium. For the Woodland - Kingscourt - Turleenan connection the magnitude of the current to be transferred, 2165A, is beyond the current carrying capacity of a single 400kV cable when directly buried. Multiple cables (also called cores), per phase, would be required and the use of a 1200mm<sup>2</sup>

aluminium conductor cable has therefore been considered in this study. A pictorial example of such a cable and its component parts is shown in Figure 1 above.

- 8) The conductor design shown utilises a round wire stranded design without segmentation. It is possible to reduce the resistance of the conductor by the use of a more expensive Milliken segmental conductor. These Milliken conductors consist of a number of individual wires stranded together into conductor segments (between four and six segments are currently being manufactured) which are twisted together to form a circular 'Milliken' conductor. The geometric arrangement of Milliken conductor wires is designed to further reduce the conductor's AC resistance and increase the cables current carrying capacity.
- 9) If the cable is required to be buried more than 3 metres in depth or to carry additional significant charging current then it would possible, subject to the selection of a suitable joint and installation design, to insert lengths of cable with an increased conductor size or if there is only a marginal requirement to insert a length of cable with a Milliken conductor of the same size (1200mm<sup>2</sup>). The use of Milliken conductors or a larger size of cable conductor would need to be considered within a contingency costing.
- 10) For buried cables it is advisable to use a water blocked conductor design. Conductor water blocking limits the extent of any water ingress into the cable should severe damage occur (for example due to a fault or being pierced). During manufacture the conductor wires are compacted together with a water blocking tape or powder. The water blocking agent is designed to swell-up when in contact with moisture and prevent damaging water penetrating through the conductor interstices for hundreds of metres. This water penetration can be rapid, particularly in an area where the cable is installed below the water table.
- 11) When cable conductors are connected together it is necessary to remove any applied conductor wire coatings and water blocking agents at the jointing position prior to assembling the joint or termination. This is necessary to ensure a good electrical connection between one conductor and the next at the joint position. If this is not achieved the connection will overheat and damage the joint.
- 12) A full radial and longitudinal water blocked cable design is thus preferred for a buried installation to limit the extent of any water penetration into the cable in case of cable damage.

## **1.2 Conductor Screen**

- 13) The conductor screen consists of a semi-conducting compound which is designed to electrically smooth the surface of the conductor to present an unblemished surface to the insulation. The conductor screen is extruded onto the cable conductor along with the insulation and the insulation screen in a single process. This is achieved using a triple headed extrusion die where the screen and insulation compounds are injected into the extrusion die simultaneously.

## **1.3 Insulation**

- 14) XLPE insulation consists of thermoplastic polythene molecules which have been cross-linked to produce a thermosetting material. The non cross-linked polythene and the cross-linking agents which are to form the insulation are extruded at high temperatures and pressures. This process must be completed under clean and

controlled conditions to prevent gas cavities, material contamination, screen blemishes and conductor eccentricity which may adversely affect cable performance.

- 15) Following extrusion the cable must undergo a period of degassing. During this process the cable is heated in an oven for several weeks to remove a substantial percentage of the by-products of the insulation cross linking process. These by-products must be removed from the insulation if the desired service life of the cable is to be achieved.
- 16) At room temperature, XLPE is a white translucent polymer. XLPE insulation is capable of operating at temperatures up to 90°C. Research organisations are active in studying the performance of XLPE materials above 90°C however at around 105 °C XLPE changes its crystalline state and becomes a transparent soft and flexible material. It is current practice to limit the temperature of XLPE insulated EHV cables to 90°C under normal operating conditions.
- 17) It is essential that XLPE insulation is kept free of water when used on extra high voltage (EHV) cables. If water is allowed to come into contact with the insulation the high electric stress in the cable causes the formation of water trees and electrical discharge which gradually destroy the properties of the XLPE insulation resulting in an electrical failure.

#### **1.4 Insulation Screen**

- 18) The insulation screen consists of a semi-conducting compound which is designed to electrically smooth the surface of the outer earthed sheath to present an unblemished surface to the insulation.

#### **1.5 Metallic Barrier**

- 19) EHV transmission voltage cables require a moisture impermeable metallic barrier around the insulation screen. A number of alternative designs for the metallic barrier have been offered by manufacturers. These may be broken down into two categories a) seamless and b) seamed.
- 20) Prior to the application of a metallic barrier semi-conducting protective cushioning and water blocking tapes are applied. In addition, outer screening wires may also be applied to meet the charging current and fault current carrying requirements for the system along with further cushioning and water blocking semi-conducting tapes.
- 21) Seamless metallic barriers (sheaths) are extruded from either lead alloy or aluminium. The manufacturing equipment required to apply these sheaths is large and expensive for manufacturers to install, maintain and operate. These sheaths are used on oil filled cables. Lead sheaths are the most common type of seamless metallic barrier being used for both underground and sub-sea applications. Extruded sheaths also have excellent water tightness and are considered to be more mechanically robust than seamed constructions.
- 22) Seamed metallic barriers consist of a flat metal strip or foil applied longitudinally with the longitudinal seam being brazed, welded or glued. The manufacturing equipment required to apply this type of metallic barrier is less expensive to install maintain and operate than a seamless design. Manufacturers offer a number of alternative materials for the seamed sheath including aluminium, copper and stainless steel.

Cables with seamed barriers are lighter and less expensive to manufacture than seamless metallic sheathed cables. Some manufacturers offer seamed barriers that use a thin metal foil with the seam being secured by means of an adhesive.

- 23) For the Woodland - Kingscourt - Turleenan transmission connections the environment surrounding the cable is such that the cable must be capable of installation and operation in a wet soil. Some manufacturers claim that metallic barriers with a seamed sheath would be capable of performing satisfactorily for the service life of the cable. However, there is a perceived risk that a latent defect in the seam could permit an ingress of water or water vapour into the cable insulation. This could result in cable failures, at multiple locations.
- 24) The Arhus – Aalborg project in Denmark uses a buried cable with a foil design of radial water blocking. These cables were placed into service in 2004 and it will be interesting to see if the longer term performance of these cables is satisfactory. Cable build and cost details for cables using a foil laminate water barrier have been obtained and these indicate that a saving in the order of 10% may be obtained over a seamless lead sheathed design. However, the risk of water ingress is considered to be sufficiently high that seamed sheaths such as laminates have not been considered further in this report. The installation of laminate sheathed cables is becoming more common place and the system owners may wish to revisit the cable sheath design should the project timescale be such that adequate installed experience in wet environments is subsequently gained by suppliers and utilities.
- 25) Notwithstanding, the possible cost benefits of seamed sheaths, for long term reliability it is recommended that a seamless lead sheath be employed for any directly buried 400kV XLPE installations in Ireland. Seamless aluminium sheaths are also available but there are fewer manufacturers of such cable designs.

## 1.6 Oversheath

- 26) A polymeric oversheath is applied over the metallic barrier. The oversheath material is a thermoplastic and is slightly permeable to moisture. Medium or high density polythene is the preferred material of choice as it offers good mechanical penetration resistance at high installation temperatures and thus reduces the incidence of damage during cable laying.
- 27) The fire performance of polyethylene is poor however and for 'in air' installations a fire retardant coating, an alternative material (PVC), or a co-extruded fire retardant compound cable covering may be used.
- 28) It is usual to apply a conductive layer on the outside of the cable either as a co-extrusion or as a graphite paint layer to allow DC testing of the oversheath to confirm integrity both after manufacture and laying.

## 1.7 Bending Performance

- 29) The installation bending radius of a cable may be as low as twelve times its diameter (12D). Such a small bending radius should only be used at positions where formers are used to constrain the cables from further bending.
- 30) For installation in a cable trench a minimum bending radius of 20D may be employed. Usually cable installers prefer to install the cable with a bending radius of 30D or above, as this eases the pulling forces required to install the cable.

## 1.8 Cable System Accessories

- 31) There are three main types of accessories:
- joints
  - terminations
  - earthing and bonding equipment
- 32) Joints and terminations are the weakest points of a cable system. This is due to the high electrical stress control requirements of accessory designs (particularly on large conductor cables) and the need for accessory component assembly on site.
- 33) In operation, thermomechanical forces act upon an accessory as the cable conductor expands and contracts with temperature. The high reliability required of a joint or termination will depend upon a fully tested manufacturing design, a specialised manufacturing process, a fully considered installation design and a high standard of accessory assembly.
- 34) The design of an accessory will have been the subject of long term reliability testing. Components will also have passed factory manufacturing tests.
- 35) Accessories are assembled onto the cable on site without the controlled environment of a factory. Reliable performance on EHV accessories therefore requires skilled jointers, specialist tooling and a suitably prepared jointing environment.
- 36) Testing requirements are set out in internationally recognised standards such as IEC 62067.
- 37) For the cable system as a whole to carry a manufacturer's warranty, it is invariably the case that a manufacturer will insist that his own jointers assemble each accessory.

## 1.9 Joints

- 38) Accessories are the weakest components in a cable system. In order to increase the reliability of the system, it can be advantageous to increase the cable section lengths and reduce the number of joints as part of the overall design solution. A reduction in the number of joints can also result in lower costs.
- 39) Cable joints connect together separate drum lengths of cable to make a continuous electrical connection. Each cable manufacturer will offer its own design of joint. The main components of a joint are:
- the conductor connector
  - the insulation and stress control
  - the radial water barrier
  - the outer protective covering
  - partial discharge detection devices

- 40) The conductor connector is required to allow the flow of current between one cable conductor and the next and to withstand any thermomechanical conductor forces. This connection is overlaid with factory prepared insulation in the form of either one or three piece joint insulation mouldings which are applied by the jointer on-site.
- 41) A metal shell is used to maintain continuity of the cable's outer sheath (or metallic barrier) and screening wires to allow the connection of any bonding leads. The metallic shell also provides a water barrier to prevent water entering the joint.

**Figure 2 EHV Joint Bay Containing Six Joints**



Photo: courtesy of Prysmian Cables and Systems Ltd

- 42) Figure 2 is a photograph of six joints in an EHV cable joint bay. This particular joint bay does not have any earthing or bonding leads installed.
- 43) The joint is enclosed in an outer protective covering (red outer box in photograph) which has sufficient electrical insulation to allow routine cable oversheath and joint protection testing to be performed (10kV dc at commissioning, 5kV dc thereafter). The joint protective covering is also designed to withstand ground surface loadings (typically 5 tonnes/m<sup>2</sup>).
- 44) The method of detecting partial discharge within a joint varies from one manufacturer to the next. The favoured method is currently to place sensors within the joint. These are used to detect incipient failure within the joint in order that a fault in service may be avoided. Partial discharge is a phenomenon which has been found to be a precursor to electrical failure. Detection of partial discharge at an early stage (particularly during commissioning testing) can prevent catastrophic failure and allow preventative maintenance.

## 1.10 Terminations

- 45) Air, SF6 Gas and oil immersed terminations are all available for XLPE cables. However, for the Woodland - Kingscourt - Turleenan connection it is likely that only air insulated cable terminations would be required for connection on to the air insulated equipment within substations. This report therefore only considers this type of termination. Figure 3 provides an example of the cable sealing end (grey insulator), of which there will be 6 per circuit end, flanked by examples of surge arrester and earth switch.

**Figure 3 400kV Cable Outdoor Sealing End (ODSE) Termination**



- 46) Cable terminations would be required to connect the cable with the overhead line or substation busbar. The overhead line and busbar would be air insulated, resulting in a lower electrical performance than that of the cable insulation.
- 47) The cable insulation separates the cable conductor from the earth using a few centimetres of insulation. Air insulation requires several metres of insulation to provide the same performance (typically the safe distance for utility personnel from a 400kV system air insulated conductor is 3.1m<sup>37</sup>). It is therefore inevitable that the cable terminations must be large enough in order to raise the live cable conductor

<sup>37</sup> "Safety Rules", NGUK/PL/ETSR/GN Issue 2, National Grid 2007 available from [www.nationalgrid.com](http://www.nationalgrid.com)



above any objects at earth potential to avoid a flashover. In order to ensure the safety of personnel and plant this electrical clearance distance must also make allowance for such effects as those produced by rain, ice and snow which will all come to rest on the outer surface of the cable termination during its lifetime. Clearances to other equipment must also be maintained to allow cable insulation withstand testing.

- 48) In general EHV cable terminations consist of :
- a conductor connector,
  - an electrical stress control cone,
  - a hollow air insulator containing insulating oil or SF<sub>6</sub> gas and covered externally with sheds,
  - an oil level or gas pressure indication, and
  - a partial discharge monitoring device.
- 49) The conductor connector (or stalk) connects between the cable conductor and the overhead line or busbar off-going connector. This stalk carries the electrical current from the conductor to the overhead line or busbar.
- 50) Unlike a power cable or a joint, the electrostatic field of a cable termination extends beyond the outer surface of the termination. Thus the insulation screen of the power cable is stripped from the underside of the conductor connector down to a point that reduces the electrical stress in the air. The electrical stress is further reduced by the stress control cone which is used to smooth the electric field both in the termination and in the surrounding air.
- 51) The insulator surrounding the XLPE cable is hollow and filled with either silicone or polybutene oil. Dry type terminations are also available which contain Sulphur hexafluoride (SF<sub>6</sub>) gas. SF<sub>6</sub> is a "green house gas" and there are limits on its use by some utilities.
- 52) For terminations filled with oil, provision must be made to accommodate the thermal expansion and contraction between the minimum and maximum operating temperatures. This may require oil compensators to be installed either within the termination or external to it. Monitoring of the oil pressure is recommended as a severe loss of oil could result in termination failure. Each termination will hold around 300 litres of oil.
- 53) The method of detecting partial discharge within a termination varies from one manufacturer to the next. The favoured method is currently to place sensors within the termination or around the earth bonding leads.
- 54) The earthing or bonding connection is attached to the termination close to the connection with the cable screening wires or metal sheath. This connection is electrically separated from the termination support structure such that a cable DC oversheath voltage withstand test may be performed.

### **1.11 Earthing and Bonding Equipment**

- 55) Special bonding arrangements require the use of earth link pillars (above ground) or link boxes (below ground) to be positioned at joint bays and terminations. Link

pillars are preferred by some utilities as these are easier to locate and maintain as they are located above ground.

- 56) Link pillars (Figure 4) or link boxes will be required at every specially bonded joint bay or termination position. One pillar or box is required for each group of three power cables. At a position where twelve joints are located a total of four pillars will be required. These pillars are connected to the joint metallic shell by means of concentric bonding cables. In order to achieve the highest current rating on the cables the connections within the link pillars cross connect one cable sheath to the next or earth down all cable sheaths, as is appropriate, as required by the special bonding design.
- 57) Where the links in a pillar or box cross connect cable sheaths, a sheath voltage limiter is installed. This device prevents excessive voltages appearing on the cable sheath (or metallic barrier) during abnormal system events.

**Figure 4 Link Pillar in Arable Field**



- 58) The bonding cables and equipment within these pillars are capable of delivering both electric shocks and burns and must be kept locked. The pillars must be capable of withstanding an internal flash-over in case of an abnormal system event. The pillars must also be protected from farm equipment and large animals by appropriate bollards and/or stock proof fencing. Each pillar will have a separate earth mat for the bonding system and the link pillar carcass. This mat consists of bare copper tape and earth rods installed below ground.

## 2 CONSTRUCTION

- 59) The method, location and routing of a cable circuit are each determined during detailed site surveys which consider the practicalities of employing a cable system.
- 60) Examples include installation, a) in air on cable supports, b) in surface trough, c) in the ground directly buried with or without thermally stabilised, forced cooled or replacement backfill, d) ducts either filled or unfilled, e) in tunnel with or without forced cooling.
- 61) The location of the cable route will be limited by such issues as, a) the total length of cable required, b) the availability and cost of land, c) swathe and access limitations, d) ground conditions and ground stability for excavation and cable installation, e) obstructions e.g. unstable ground, difficult terrain, tree roots and immovable structures, f) disturbance to the environment and stakeholders, g) maintenance access, h) suitable locations for above ground equipment.
- 62) Access to the entire route must be agreed before works can commence. Ideally this will be performed prior to the commencement of construction works or a risk assessment will have been taken on each area of doubt. The following paragraphs in this construction section detail the main tasks to be undertaken.

### 2.1 Site Accommodation and Storage

- 63) It would be necessary to locate a local site storage facility along the cable route where site offices may be located and materials stored. This storage location would vary from site to site and depend on the availability of local land for hire, availability of utilities, security considerations, environmental suitability and the proximity of the site to main roads.
- 64) If the site accommodation is to be located on farm land then the site set-up area should have the top soil removed and stored separately for final reinstatement. A suitable surface is installed for the placing of site and security offices, welfare facilities, cable drums, aggregates, tiles, timber and vehicles etc. The area should then be made secure with suitable fencing and gates.
- 65) Dependent upon the location, generators, fresh and waste water storage tanks, waste material and flammable gas storage will be required to support the operational and welfare facilities. Floodlighting may also be required.
- 66) Access to the site may require traffic management to be installed to allow safe entry and egress from the site accommodation.

### 2.2 Enabling Works

- 67) Enabling works are those construction works that should be performed before the main works begin. The works may, for example, enable access to the site, confirm the route is free of impassable obstructions and/or perform advance construction work at specific locations (such as drilling locations) to enable the free flow of the main work programme.
- 68) Prior to commencing the main excavations it would be necessary for the contractor to identify any route obstructions and make sure that an economic solution exists to cross or divert each obstruction or to reposition the cable route accordingly.

- 69) Details of recorded services would be obtained from utilities and discussions held with land owners regarding any services on their property. This will include unrecorded services installed by the land owner such as land drains.
- 70) Underground services are located by trial hole excavation with the assistance of location equipment (such as ground penetrating radar).
- 71) Where roads are to be crossed a decision must be made on the method to be used. The installation of polythene or uPVC ducts is common place and this may include a concrete encasement. This will require traffic management with the timing of road works being agreed with the community council and other interested stakeholders. For busy carriageways the use of trenchless methods such as directional drilling may be necessary to prevent unacceptable traffic disruption.
- 72) At railway crossings, where it is not possible for the cables to cross the railway on an existing structure, such as a road bridge, crossings are usually performed using trenchless methods to avoid disruption to railway services.
- 73) There are a number of methods available for river crossings. These include bridging, drilling or tunnelling beneath the river bed, dredging a trench in the river bed and laying the cables direct on the river bed or in ducts. These methods may also be applicable to standing water such as ponds or lochs. The preferred method for crossing the rivers is the use of nearby existing structures such as road bridges or failing this by directional drilling or boring.
- 74) In order to gain access to some areas of the route it may be necessary to install temporary access roads leading from public roads to the working swathe. It may also be necessary to improve the surface of any existing farm tracks. Temporary access roads will be removable and usually consist of either aggregate installed on a porous membrane or timber/metal matting.

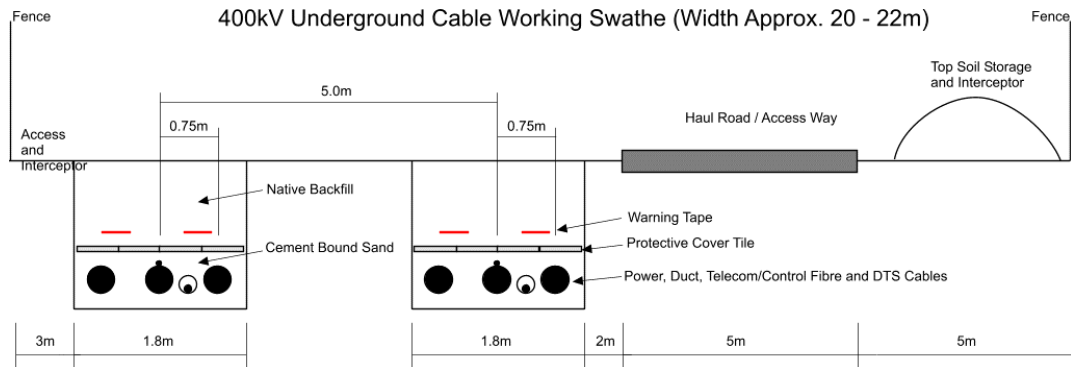
### **2.3 Cable and Circuit Spacings**

- 75) The need to keep the cable conductors from becoming too hot requires that they be adequately separated when buried. For the Woodland - Kingscourt - Turleenan connection six aluminium conductor cables are considered by this report and these would normally be arranged in two groups of three cables. The space requirements for these groups of conductors, plus the haul road and width for the temporary storage of spoil from the trenches, amounts to a working swathe some 20m-22m wide.
- 76) Figure 5 illustrates a swathe arrangement. The cable trench containing three cables will be approximately 1.8m wide. A 3m access way is allowed between the outer trench and the fence to permit access from both sides of the trench during such activities as cable pulling and the installation of any drainage. Thermal separation between groups of cables for the same circuit will be around 5.0m. The trench width and circuit separations are approximate as these will be dependant upon the cable build available from the cable manufacturer.
- 77) A width of 5m is allowed to install a haul road. The haul road will be widened at suitable locations to provide passing places. This road will allow construction traffic to move up and down the swathe collecting and delivering materials with minimal disruption to local roads. A 2m standoff between the edge of the road and the cable

trench has been provided to prevent unnecessary soil loading on the trench wall due to haul road traffic and to allow pedestrian access to the cable trench.

- 78) A storage area of 5m has been allowed to retain top soil for the duration of the works.

**Figure 5 General Working Swathe Cross Section**



## 2.4 Swathe Preparation

- 79) On a large project works would need to progress throughout the year. Generally the best time for working on the land is between April and October when wet weather is less prominent.
- 80) Environmental factors should be considered for example, consideration should be given to the avoidance of disturbance to breeding birds as a result of the construction activities within their habitat.
- 81) If required, following a land drainage study, a drainage system would be installed to collect water running across or off the swathe. Where necessary this drainage system would include settlement ponds to avoid silt entering water courses.
- 82) Within the swathe the top soil would be stripped and stored to one side. An all weather temporary haul road would then be installed along the route between access points onto local roads. These access points would require to be agreed with the community council and interested parties. In principle the haul road would carry as much as possible of the construction traffic. However, some vehicle journeys on local roads would be inevitable to reach the site access points and make use of such facilities as road bridges where rivers or railways cut across the route. Wheel washing facilities would require to be maintained at all haul road egress points. Road signage would have to be provided to direct construction traffic towards and away from site access points over predetermined and stake holder consulted routes.
- 83) The working swathe would be protected by fencing with limited and controlled access and egress to the site.

## 2.5 Excavation of and backfilling of direct buried trenches

- 84) Along the cable route the trenches would be excavated to accommodate the power cables. Additional excavations would be required at the joint bay positions to accommodate the power cable joints. If the ground is waterlogged dewatering may also be necessary.
- 85) In order to keep the cable trench clean and safe, for both people in the trench and the cables, it is good practice to shore the trench. Shoring may be provided in a number of ways. For example, traditional double sided close timbering shoring (Figure 6), hydraulic shoring or box shoring. Another option is to “batter back” the sides of the excavation to a safe angle however if the ground consists of wet sand or silt, the safe angle of batter could be less than 10° above horizontal with insufficient room within the swathe for such a wide excavation. “Battering back” would also require the use of permeable membrane sheeting to prevent foreign material such as stones from falling into the trench and being mixed in with the cable surround where it could damage the cables.

**Figure 6 A Close Timbered Cable Trench**



- 86) Excavation of the trenches would include joint bay excavation. A joint bay for three joints will be in the order of 10m long and 3m wide and approximately 2m deep. The base of the joint bay must be level and a concrete pad installed (some 150mm thick with light reinforcement) as a working surface. The sides of the excavation are shored to prevent collapse.
- 87) On completion of the excavation the cable trench bottom is cleared of sharp or large objects and any free water is pumped from the excavation.
- 88) Following the installation of the cables, auxiliary cable ducting, CBS and cover tiles in the outer trench, the excavated material which was not removed from site would be used to infill the trench and would be compacted. The inner trench nearest the

haul road would then be excavated and the excavated material used to top-up the backfill of the outer trench. The remainder of the excavated material would be stored on site, separate from the top soil and used to complete the backfill of the trenches nearest the haul road and joint bays following cable system installation. Once the backfill is completed, the surplus material would need to be removed from site as waste / landfill or with the owners permission distributed onto the land.

## **2.6 Excavation and backfilling of ducted trenches**

- 89) Where cables are installed in ducts using open cut excavations across roads, these would be installed using road traffic control, road surface breaking, excavation, ducts placement and shuttering, concrete pouring, tile and warning tape installation with backfilling following on. The cables would then be installed in the ducts at a later date
- 90) For a fully ducted cable system the ducts would be installed from joint bay to joint bay. However, a fully ducted system is not considered advantageous for this project unless a significant portion of the route is to be installed under roads where ducted installations are preferable due to the road traffic congestion and disturbance levels of open cut systems. The PB Power selected cable route corridor does not offer a prospect of an installation of this type as such major roads as exist within the corridor cross, rather than lay laterally along, the cable route corridor.

## **2.7 Cable Installation for Direct Buried Installation**

- 91) Once the bottom of the cable trench has been cleared of sharp and large objects, a cable bedding of CBS 100mm thick is laid. The CBS is tamped into place to form a firm surface upon which cable installation may take place. This thickness may be increased to accommodate a fibre optic communication duct, alternatively the fibre optic duct may be installed between or above the power cables or above the cover tile where plough damage is not anticipated.
- 92) As the trench is being prepared the drums containing the power cables would arrive at one of the joint bay positions. The area around the joint bay would have been prepared to accept the drums onto a hard standing. The drums would be delivered to site by a low loader or cable trailer. A typical low load trailer is 18m long, 2.5m wide and has a ground clearance of 560mm. The tractor and trailer have an unladen weight of around 28 tonnes giving a gross weight of around 50 tonnes for a 730m cable length of lead sheathed cable.

**Figure 7 Cable Drum Carrying Trailer**

- 93) Transporting the drum over motorways and major roads should not present any problems and the low loader width is such that a Police escort should not be necessary.
- 94) Specialist hauliers would be required to transport large drums. Such hauliers can provide low load trailers with rear wheel steering and tandem tractor units for steep inclines. Figure 8 shows a low bed trailer height of around 450mm. The trailer is also fitted with rear wheel steering.
- 95) Different manufacturers use different drum sizes to suit their cable manufacturing facility and it is important that drum weights and dimensions are fully investigated at the contract tender stage.
- 96) Transporting the drum through country towns and along country lanes may present problems and the temporary removal of street furniture, overhanging tree pruning, bridge strengthening, possible road closures and other road safety and access measures may be necessary.



**Figure 8 Cable Drum Load Transversely onto a Trailer**



- 97) It would be recommended that a detailed transportation and access survey be undertaken for all sites if cable undergrounding is to take place.
- 98) Upon arrival at site the cable drum would either be unloaded at a temporary storage site or taken directly to the cable pulling-in position.

**Figure 9 Offloading Cable Drums**



- 99) A cable pulling system would be installed into the trench. Traditionally this is a steel bond and winching system with free spinning cable rollers placed along the bottom of the trench. Other methods include the use of motorised rollers or tracked caterpillar drives. Winching equipment is normally diesel powered however generators will be required to power electrically operated cable pulling systems.

Communication during the cable pulling operation is by radio hand-set to supervisors strategically positioned along the cable route. The winch or power roller system operators are also included in this communication system.

- 100) The cables are large in diameter (nominally 122mm), heavy (around 26kg/m) and delivered in long lengths on heavy drums (of approximately 23 Tonnes). The cables require a surround of a selected backfill at a controlled separation distance. They are not therefore suitable for mechanical ploughing into the ground as may be employed with very much smaller and lower lighter lower voltage power cables.

**Figure 10 Cable installation in an Open Cut Trench**



- 101) The cable drum is threaded with a spindle and raised from the ground using hydraulic jacks mounted on lifting frames (jack stands). The cable is then pulled from the drum into the cable trench and onto rollers. Sufficient cable is pulled from the drum until adequate cable is available in the far joint bay for jointing onto the next cable length. The cable is then lifted off the rollers onto the trench floor. This process is repeated for all cables following which the rollers and pulling equipment is removed from the trench. The cable is then positioned in the trench at the correct spacing.
- 102) Following the power cable installation any earth continuity conductor cables, installed with each group of three power cables, are installed with a mid-point transposition of the section length from one side of the centre cable to the other.
- 103) Distributed temperature sensing (DTS) fibres or DTS ducts for fibres would be placed on the cables and/or in the backfill at this stage. These fibres are used as part of a temperature monitoring system to calculate the cable conductor

temperature along the cable route to estimate the load capacity of the cables and detect any locations where soil or cable surface temperatures are abnormally high.

- 104) Cement bound sand (CBS), delivered by mixer (Figure 11) would then tamped into position around and over the cables to a depth of approximately 100mm to 150mm above each cable. Cover tiles containing a warning are then installed above the cables, these are fabricated from either reinforced concrete or reclaimed polymeric materials (retailed as Starboard).
- 105) Telecommunication and control cable ducts may also be installed alongside or above the power cables. These would be suitable for the installation of a fibre optic cable.

**Figure 11 Delivery of CBS to the Cable Trench**



- 106) Following the placing of cable tiles the timber shuttering is removed and the trench is then further backfilled with previously excavated material. The backfill is compacted and includes warning tapes which are generally installed 150mm above the cover tiles.
- 107) The duration of the excavation, cable installation and backfilling works for the six cables in a cable section will depend on the nature of the ground e.g. rock content, dewatering content etc. In general it would be expected that the twelve cables would be installed and backfilled over a 700m section in around eight or nine weeks.

## **2.8 Jointing**

- 108) Once the cables have been installed into a joint bay a temporary weatherproof structure would be erected over the bay. The joint bay would be cleaned internally

and the cables prepared on a concrete joint bay floor. The jointing operation would require dry, clean conditions and good lighting.

- 109) Jointing should only be performed by trained personnel. It is also necessary to ensure that these personnel are trained in safe methods of work, particularly when working close to other transmission lines that may induce dangerous voltages onto the cables being jointed. In most circumstances the jointing team would be employees of the company supplying the cable system or alternatively (and less preferable) jointers from a contractor that have received training from the cable system supplier to a standard suitable to assemble the joints and maintain the suppliers warranty.
- 110) Either three or six power cable joints may be made off in a joint bay. There are six main stages in the jointing process which are as follows:
- Preparation of the joint bay and checking of materials, drawings, assembly and safety instructions (this action is required to ensure that all components, equipment, drawings and instructions are available before jointing commences),
  - Preparation of the cables including positioning and straightening,
  - Assembly of the accessory primary insulation,
  - Assembly of the accessory secondary insulation,
  - Assembly of the link equipment and auxiliary cable equipment onto foundations or pits previously installed, and
  - Following joint bay backfilling, initial secondary insulation checks by application of DC voltage.
- 111) The duration required to complete a joint bay containing three joints will depend on a number of factors including the number of joint bays available for jointing (backlog), the number of jointers assigned to the work programme for the project, the joint complexity, the location of the joint bay, access or working restrictions, any induced voltage working requirements and the speed at which each jointer feels competent and safe to assemble each type of accessory. Once a jointing team is available to assemble a joint bay the process should take in the order of three to four weeks. This period includes the assembly of the jointing shelter through to backfilling.
- 112) A power supply would be required in the joint bay to operate equipment and lighting and eliminate control. Silenced generators would be positioned at joint bays where noise pollution may cause a disturbance. The general objective would be to reduce noise levels to 40-45 dB(A) at night, and 50-55 dB(A) during the day, at the nearest residence or at the boundary of the premises. These levels may vary with the requirements of local agreements and legislation.
- 113) The jointers' transport is normally a covered van. Self loading vehicles would deliver and collect the jointing structures and fencing. Security patrols would normally be active with regular night time visits to any excavated joint bays and trenches.
- 114) Permanent stock proof fencing and/or bollards would be erected to prevent damage to any equipment which is not buried once the joint bay has been backfilled.

## 2.9 Jointing Terminations

- 115) The cables would be brought out of the ground into a sealing-end compound or substation that is fenced for safety and security reasons.

**Figure 12 Weatherproof Sheeted Enclosure for Cable Termination Assembly**



- 116) The method of installation of the cable terminations depends on the supplier as each use differing methods. The first is to make the termination off in the horizontal position and then to raise it to the vertical position in its completed form. The second method is to assemble the termination in its final vertical position.
- 117) The advantage of the first method is that the termination can be assembled at ground level in much smaller weatherproof enclosures. Some manufacturers do not consider such a technique as suitable for their design of cable termination and have concerns that the internal parts of the termination may move during the lifting process and result in the termination failing in service.
- 118) Assembling the termination in the vertical position requires that a large weatherproof scaffolding structure is assembled (Figure 12). This structure would be covered with sheeting. These structures must be carefully designed to withstand a high wind load and are secured with guy ropes and anchored with ground weights. The size of the structure will depend on the spacing of the cable terminations for electrical clearance and whether or not the installer uses a crane or an internal beam and hoist arrangement to install the termination insulator over the prepared cable end. (Note that the OHL terminal tower in the photograph is a double circuit tower rather than a single circuit tower planned to be used on the Turleenan – Kingscourt – Woodland 400kV connections)

- 119) The large scaffolds may take two or three weeks to construct after which the cables are pulled into position up the structure. The jointers then prepare and terminate the cables. Following assembly of the termination the scaffolding structure is dismantled.
- 120) Link equipment is then installed inside the substation (normally secured to the termination support structure) which provides a removable earth connection to the cable termination.
- 121) Partial discharge sensing cables, used to carry signals of unwanted electrical discharge from within the accessory, are terminated into a local marshalling box. The DTS fibres are also terminated into a local marshalling box. These marshalling boxes are located within either the substation or a building within the cable sealing end compound.
- 122) Following installation of the cable, the termination of three cables may take around 7 to 8 weeks to complete. This time period includes for the erection and dismantling of the scaffold.

## **2.10 Swathe Reinstatement**

- 123) Following installation of all cable and joints in a section the swathe would be cleared. This will include the removal of any remaining security fencing, uplifting and removal of the haul road and temporary hard standing areas reinstatement of surfaces and top soils.
- 124) Where necessary this reinstatement may include replanting of hedges, replacement of fences, removal of temporary land drains and settlement ponds, reinstatement of permanent land drains and the like.
- 125) If trees are removed, these would only be replaced if their roots did not interfere with the power cable installation. The allowable distance of any tree from a cable would depend on the type of tree and its expected future growth.
- 126) Where beneficial, and prior to top soil replacement, the ground would be subject to sub-soil ripping to break up the compaction due to construction activities.
- 127) Permanent and maintained marker posts would be installed at field boundaries and road crossings to warn of the presence of underground cables.

## **2.11 Buildings Over the Cables**

- 128) The building of permanent structures is not normally permitted over directly buried cables for reasons of maintenance access and safety.

## **2.12 Maintenance and Life Expectancy of Cable**

- 129) A cable system design life of 40 years is provided by manufacturers with warranty periods of up to 10 years being provided.
- 130) Maintenance of power cable systems falls into three categories:
- route patrols and inspections,
  - planned service maintenance, and

- emergency fault repairs.
- 131) Most cable damage is the result of third party activity. Regular patrolling of the cable route looking for third parties working close to the cable route is a preventative measure. The frequency of such patrols would depend upon a utilities view of the cost benefits of preventative maintenance and a risk analysis of third party activity likely to take place along the cable route.
- 132) Routes where cables are buried under roads which are likely to be opened by other service providers are generally at greater risk of damage than cables running through pasture. During a patrol, inspections would be made of all above ground furniture to check externally that they have not been damaged or vandalised and that security locks are in place. A patrol should also check that any third parties performing activities which may be hazardous to the cable system are working in an informed, controlled and safe manner.
- 133) Planned service maintenance would require the opening of link kiosks or pits. Internal inspections of the pillars would check the condition of the pillar and the equipment contained within. Cable oversheath integrity tests would be performed at link pillar positions as would the tests on the sheath voltage limiters, where these are installed. These tests consist of applying a potentially dangerous DC voltage and thus are only performed by a trained test engineer under controlled test conditions and safe working practices.
- 134) Some cable manufacturers are offering “maintenance free” systems. However this statement refers only to planned service maintenance. It is advisable to check the condition of any equipment which is susceptible to third party interference. If damage to the cable system does not immediately cause a primary insulation failure (e.g. as the result of a glancing blow to the cable by an excavator) any puncturing of the oversheath or metallic sheath or barrier would allow water ingress, corrosion and progressive XLPE insulation deterioration leading to primary insulation failure. Unlike oil filled cables, XLPE cables do not contain any pressurised liquid which, when monitored, would indicate a puncture to the cable’s metallic sheath. It would be recommended therefore that unless a system of continuous monitoring is installed for the surge voltage limiters (SVL) and the cable oversheath that regular oversheath integrity tests (preferably annually) be performed.





**APPENDIX 7 - SCOPE OF CIVIL ENGINEERING WORKS FOR COST ESTIMATES**


RPS Basis of Civil Works Cost Estimates





**EIRGRID  
N-S INTERCONNECTOR  
AUGUST 2008  
PRICING DOCUMENT**

**DOCUMENT CONTROL SHEET**

<b>Prepared by:</b>	Mark Magee
<b>Office of Origin:</b>	Letterkenny
<b>Checked by:</b>	Mark Magee
<b>Office of Origin:</b>	Letterkenny
<b>Report Ref:</b>	IBE0220/Reports
<b>Status:</b>	Draft
<b>Revision No:</b>	1
<b>Date of Release:</b>	August 2008
<b>Approved and authorised for issue:</b>  <b>Name: Mark Magee</b> <b>Position: Associate</b>	

---

---

# ***Contents***

Notes on Pricing

General Principles

Rates – General Inclusions

Route Refinement, Detail Design and Method Statements

Preparation and Reinstatement of the Working Swathe

Excavation, Backfill and Reinstatement

Particular Locations and Conditions

Reinstatement

Documentation

---

---

## **INTRODUCTION**

This document has been prepared in support of the costing schedule prepared to establish the civil costs associated with the underground installation of the N-S Inter-connector.

The costing is based on the rates used in previous projects through similar terrain, e.g. the South North Gas Pipeline constructed by BGE (Northern Ireland) in 2006. This information has been supplemented by the Spon's Civil Engineering and Highway Works Price Book, 2008 (Langdon, 2008).

There are four schedules included in the associated excel spreadsheet, as detailed below:

Schedule 1 – Preliminary Work and General Charges (Lump sum costs)

Schedule 2 - Landscape Type 1 (Rate per km UGC)

Schedule 3 – Landscape Type 2 (Rate per km UGC)

Schedule 4 – Trenchless Crossings (Additional cost for river, road crossings to be carried out using trenchless technologies.).

## **NOTES ON PRICING**

### **General Principles**

In the following Schedule of Rates, the descriptions attached to the respective items are intended only as a brief description sufficient for identification of and not exhaustive detailing every operation involved in carrying out the work described. Metric units of measure and metric quantities are defined by the use of the International System of Units (SI Units).

Where stage measurements are given as for example 2.00 – 2.50m it means exceeding the former and not exceeding the latter dimension.

The rates, prices and sums entered against the respective items are the full inclusive rates, prices and sums to construct, complete and maintain the finished work described under such items and as covering all liabilities, obligations and risks arising out of the Contract.

The quantities listed are included as an aid to the costing process. These are indicative quantities only, they are not guaranteed.

Notwithstanding the foregoing, certain “general obligations” are given as items in “Preliminary Work and General Charges”.

The particulars contained in the following clauses of these notes about matters included in specified items and rates are not to be read as exhaustive.

### **Rates – General Inclusions**

The rates ‘Schedule of Rates’ shall be deemed to include for the following:-

- 
- i. All additional costs of construction of the Works, caused by the restrictions due to the nature of the ground, the location of existing poles, markers, pylons, lamp standards, traffic lights and signs, buildings, boundaries and protected trees, overhead cables and underground services, land drains, sewers, culverts, etc.
  - ii. All additional costs of construction of the Works due to the restrictive width, nature and circumstances of working in and adjacent to roadways in rural, suburban and built-up areas.
  - iii. All restrictions on the use of roads by Local Authorities/owners or by their condition, alignment or profile that prohibits, prevents or limits their use.
  - iv. The provision, maintenance and subsequent removal of all temporary roads and tracks necessary for the execution of the Works including additional temporary Works to continuous temporary roads and tracks at unstable ground conditions and where land is liable to flood.
  - v. The removal of mud slurry from the surface of the working width due to the movement of plant, equipment and vehicles including making up levels with approved imported material.
  - vi. The drilling of post holes in rock, road surfaces and the like for route marker fencing, temporary fencing, permanent fencing including boundary and security fencing at installation compounds.
  - vii. Additional labour etc., in crossing unlisted hard surfaces and bottomed tracks etc., and the like.
  - viii. The care necessary to avoid damage to roads, footpaths and any other surfaces outside the limits of trench, restoration and all costs of repairing any damage to the satisfaction of the particular Authority /owner concerned.
  - ix. The extra care necessary to avoid damage to adjacent protected monuments, trees, shrubs and the like.
  - x. Watching and lighting, traffic control, temporary plating where necessary, safety barricades and temporary cross-overs for foot and/or vehicular traffic to footpaths, entrances, private drives and other roads where necessary and to the satisfaction of the Engineer and Local Authorities where working in public highways, private roads, tracks, footpaths, margins, verges and the like.
  - xi. Crossing all unmade and un-surfaced tracks, green lanes and the like.
  - xii. Hand digging trial holes to locate services, machine or hand digging trial holes to predetermine the location of rock, the necessity for the use of dewatering or stabilizing



---

equipment and generally investigating the route of the UGC, backfilling and temporary reinstating.

- xiii. Cabling on side slopes irrespective of the angle of the slope from the horizontal.
- xiv. The installation of pre construction drainage such as temporary cut off drains in locations where forward grading and side terracing or cross benching are carried out or where the Contractor considers it is required to control surface and sub surface water. including backfilling, consolidating excavations and reinstating the ground to the original full depth and contours.
- xv. Additional cost of all plant movement or preparation and grading of running surface where rock, including solid bed rock, occurs at steep forward or back slopes.
- xvi. All haulage, fees and charges for disposal of surplus or unsuitable excavated material on or off the site.
- xvii. Crossing under overhead electricity, telephone and other cables which necessitate the use of precautionary measures in accordance with the Specification and requirements of the Authorities concerned.
- xviii. All additional costs of construction of the Works in connection with general and specific timing restrictions insofar as such timing restrictions are either made known to the Contractor or could in the opinion of the Engineer reasonably be established or assumed by adequate pre-tender investigation and enquiries on the part of the Contractor.
- xix. All additional costs of construction of the Works in connection with working at times other than usual working hours where such working is necessary to maintain continuous access, to comply with the requirements of Statutory Bodies, Gardai etc., and including any other reason, which in the opinion of the Engineer, would reasonably be established or assumed by adequate pre-tender investigation and enquiries on the part of the Contractor.
- xx. All additional costs for draining the route and keeping the excavations free from water where no cut-off drains are installed by the Contractor.
- xxi. All other measures necessary for the proper completion of the Works not specifically mentioned above.

### **Route Refinement, Detail Design and Method Statements**

The Rates for Route Refinement, Detail Design and Method Statements shall be deemed to include for the following:-

- i. Contacting all Local Authorities and Utilities to locate the position of all services

- 
- ii. Exploratory trenching, bore holing, hand digging, trial pits (including saw cutting, backfilling and reinstating all as specified) to locate the exact position of all underground services in order to define the exact UGC route and profile.
  - iii. Provision and use of mains and cable locators, hand digging to locate and expose existing underground services culverts etc. and any necessary temporary supports and tunnelling under.
  - iv. Setting out the line of the UGC, including providing facilities for the Engineer for checking the setting out.
  - v. All investigations, surveys, mapping etc. required, to determine the alignment (horizontal and vertical) of the UGC.
  - vi. Provision of detailed drawings for approval of the Engineer showing horizontal and vertical alignment, position of all underground and overhead services, boreholes, trial-pits and probings.
  - vii. Provision of method statements for each operation including assessment of safety and environmental hazards.
  - viii. All costs associated with the design of the temporary works

## **Preparation and Reinstatement of the Working Swathe**

### **Preparation of the Working Swathe Generally**

The rates for the preparation of the working swathe including any additional widths shall be deemed to include for the following:-

- i. Carrying out condition survey of existing areas, surfaces and buildings along the route including record photographs and reporting.
- ii. Identification, flagging and protection of trees.
- iii. Removal and replacement, as specified, of small trees in public open spaces, grass margins and the like as specified.
- iv. Removal of hedges, fences walls and the like across the working width including installation of straining posts etc.
- v. Removing earth banks and the like.
- vi. The provision and maintenance of route marker fencing to delineate the working swathe and subsequent removal after completion of the reinstatement works and, if instructed to leave the fencing in position, the cost of the fencing materials.
- vii. Access bridges for movement of plant, machinery, equipment and livestock within the working width and over crossings.

- 
- viii. Cleaning up, removal of all temporary works, replacing and grading of ground to existing formations, removing and disposing off-site of stones exceeding 50mm diameter and reinstating surfaces over the working swathe on completion as specified including the reinstatement of stripped topsoil.
  - ix. Preparation of and reinstating of the surface of unstable ground.
  - x. Excavating surface rock outcrop obstacles including boulders and removal offsite.
  - xi. The provision and subsequent removal of temporary fencing and gates at gaps in fences, walls and hedges abutting onto roads.
  - xii. Provision of 'working width' drawings detailing all of the above

### **Temporary Fencing**

Temporary fencing has been measured on each side of the working swathe where applicable.

The rates for temporary fencing on the working swathe and working area shall be deemed to include for the following:-

- i. Removable panels or gates as required.
- ii. The additional fencing due to increasing the working width at crossings and the like.
- iii. Maintaining fencing panels and gates until the completion of the contract.
- iv. Straining posts and struts at 120 metre centres and at any change of direction including contours.
- v. Reinstating and making good at post holes after removal of fence posts.

### **Stripping of Topsoil**

The rates for the stripping of topsoil shall be deemed to include for the following:-

- i. Stripping the full depth of topsoil and stacking at the side of the working swathe in a manner to avoid integration and contamination with sub-soil or top cover of unsuitable soil structure.
- ii. Restricted working or the disposal and return of excavated materials where there is insufficient stacking space.
- iii. Increase in bulk.
- iv. Spraying stacked topsoil with an approved weed killer.
- v. Archaeological Costs associated with monitoring of the topsoil stripping and subsequent discovery, excavation and reporting of archaeological finds.

---

## **Reinstatement of Stripped Topsoil**

Reinstatement of stripped topsoil has been measured as the area or volume of the topsoil before stripping or excavation.

The rates for the reinstatement of stripped topsoil shall be deemed to include for the following:-

- i. Breaking up exposed subsoil with approved machines and equipment to a depth of 600mm and reducing to a loose and workable condition including traversing lengthwise and across the working swathe taking care to avoid damage to drains and picking up stones exceeding 150mm in diameter over the area of the broken down subsoil and remove and dispose off site including areas where excavated materials have been stacked.
- ii. Bulking of reinstated topsoil and excavations.
- iii. The provision of extra topsoil required to compensate for subsidence in backfilled excavations.
- iv. Breaking up and tining topsoil within the working width to its full depth including replaced topsoil and where topsoil has not been stripped, including traversing the working swathe and removing stones, all as described in sub-item (i).
- v. Breaking down the final spread surface to a fine tilth ready for replanting and sowing.

## **Subsoil Reinstatement**

The rates for deep breaking up of subsoil exceeding 600mm deep shall in addition to item

- vi. Under 1.4.4 "Reinstatement of Stripped Topsoil" be deemed to include the use of machines with sufficient power and traction and fitted with agricultural equipment to reduce the subsoil to a loose and workable condition acceptable to the Engineer.

## **Excavation, Backfill and Reinstatement**

### **Excavation and Backfill Generally**

The cover stated, shall be the cover over the cable measured from the top of the cable to the original surface ground level or reinstated ground level, whichever is the lesser.

The rates for excavation and backfill generally shall be deemed to include for the following:-

- i. Excavating by whatever method is used and in whatever material is met, including brash, shale, chalk, flint, rock and materials of a like hardness, including rock wherever ripping equipment is used and boulders not exceeding 0.50 cubic metres but excluding rock which can only be removed by pneumatic or hydraulic hammers/breakers.

- 
- ii. All excavations and backfill excluding those contained in "Preparation of the Working Width Generally", "Stripping Topsoil" and "Reinstatement of Stripped Topsoil".
  - iii. Increase in bulk.
  - iv. Trimming and grading bottoms to levels and contours and additional labour in hand packing.
  - v. Upholding with trench sheeting or the like or battering sides of trench to satisfy the safety requirements and regulations.
  - vi. All measures required to keep excavations free from water and cleaning of silt from land drains, ditches or watercourses due to the disposal of water and the installation of pre construction land drains required to keep the trench and/or the right of way free of water where considered necessary by the Contractor.
  - vii. Temporary chutes, dams, cut off drains, pumping, de-watering or other measures necessary to deal with water from existing land drains, open drains, ditches, streams, canals or rivers and the like.
  - viii. Additional excavation required at joint bays and for timbering, overbreak, battered sides and the like or to allow for working space.
  - ix. Backfilling, ramming and thoroughly consolidating in layers to top of excavations including all additional labour in compacting and ramming with soft material obtained from the excavations.
  - x. Provision of electric cable warning tape.
  - xi. The removal and disposal of surplus excavated and unsuitable material.
  - xii. The extra care and labour using hand digging to locate and expose and to avoid damage to existing underground services, culverts etc., any necessary temporary supports and tunnelling under, and any costs associated with making good any inadvertent damage to third party services.
  - xiii. The extra care necessary to avoid damage to road, footpaths, kerbs, fences or walling, making good any damage occasioned thereto and any costs associated with making good any inadvertent damage to third party services..
  - xiv. Location, position of, tracing, and cutting out land drains over the "Trench Width" into the undisturbed ground on each side of the trench for a distance of 1000mm measured at right angles to the trench.
  - xv. Temporarily plugging open ends of cut land drains.
  - xvi. Reinstating all original accesses across the Working Width.
  - xvii. Excavating and backfilling in marshy or waterlogged, silty or the like ground conditions including consequential works to hardstandings, temporary roads, walkways, etc., in river, canal and stream approaches.

- 
- xviii. All coffer damming, sheet piling and the like.
  - xix. Bank and embankment works designed by the Contractor at rivers, canals, streams and railways etc.
  - xx. Flumes, pumps and the like and all measures required to dispose of, or control, water in river, canal and stream approaches etc.
  - xxi. Excavating and backfilling across ditches, streams, hedges, field boundaries, road boundaries etc. including cleaning out and reforming cross or parallel road ditches over the working width.
  - xxii. All necessary protective measures and works through river, canal, stream and railway banks, embankments and approach areas.
  - xxiii. Removing all temporary coffer damming and protective works and reforming banks and embankments to the original shape and profile including making good to existing protective works.
  - xxiv. Suitable fencing at deep excavations which may be required to be retained for extended periods of time

**Excavation, Backfill and Reinstatement in Public Roads, Footpaths Entrances, Tracks, Private Drives, Private Roads and the like.**

The rates for excavation, backfill and reinstatement in public roads, footpaths, entrances, tracks, private drives, private roads and the like shall in addition to the items given under "Excavation and Backfill Generally" be deemed to include for the following:-

- i. Liaison with Roads Service and Councils in terms of road closures, diversions etc. Compliance with NIRAUC regulations, Road Traffic Act and Council requirements for reinstatement and provision of Traffic Management Plan.
- ii. All appropriate items given under "Preparation of the Working Width Generally" and "Reinstatement of Stripped Topsoil".
- iii. Saw cutting the existing road wearing surface and the underlying base courses and concrete slabs to their full depth with a diamond impregnated saw to form a clean vertical edge to each side of the road cuttings.
- iv. Excavating through tarmacadam/asphalt, concrete, reinforced concrete, cobble stones/setts, paving slabs or similar surfacing, base and sub-base not exceeding 450mm deep and setting aside and afterwards replacing where necessary.
- v. Temporary crossovers for foot and/or vehicular traffic.
- vi. Crossings of and carriageways, footpaths, entrances, tracks, drives or roads in which the UGC occurs.
- vii. Crossing all side entrances and all public and private drives and crossover entries.

- 
- viii. Any necessary removal and later bringing back of excavated material including the provision of any necessary temporary storage tips.
  - ix. Tunnelling under kerbs or breaking or easing out and reinstating same.
  - x. Tunnelling under walls or other boundaries or taking down and reinstating same, including the supply and transport of all necessary precautionary works to prevent the collapse of such walls and boundaries during construction.
  - xi. Crossing and cleaning out and reforming cross or parallel road ditches.
  - xii. Temporary reinstatement as specified.
  - xiii. Additional temporary and/or permanent reinstatement including saw cutting required at joint holes for positional welded joints, trial holes on the route of the UGC.
  - xiv. Any extra difficulties at intersections and junctions with other roads.
  - xv. All other measures required for the safe execution of the Works and by the particular Authority/owner concerned, including provision of warning signage, traffic management systems.
  - xvi. After examination of road surfaces, footpaths including kerbs, flags and cobble stones/setts, making good all damage resulting from the Works to the satisfaction of the local Authority concerned.
  - xvii. Where a footpath, entrance, track, private drive, private road is constructed in a filled area and there is, for example, extensive ash, shale, industrial or demolition remains under the surface, this shall not be considered as qualifying for an extra over rate and shall be deemed to be included.
  - xviii. Permanent reinstatement in footpaths, entrances, tracks, private drives, roads and the like will be measured on trench width only.
  - xix. For the computation of permanent reinstatement in public roads and the like, the trench width shall be measured as 150mm wider than the specified trench width in tarmacadam/asphalt and tarmacadam/asphalt surfaced areas and 300mm wider than the specified trench width in concrete.
  - xx. Road cleaning and sweeping during construction on daily basis or as required.

**Sand, Crushed Stone, Cement Bound Granular Material or Concrete Imported Filling to Trenches**

The rates for backfilling trenches with imported filling materials shall be deemed to include for the following: -

- i. The procuring, loading and carting of such material.
- ii. Backfilling and compacting as directed by the Engineer.

- 
- iii. Any additional quantity required at joint bays, trial holes on the route of the UGC, timbering, over-break, battered sides and the like.
  - iv. Backfilling in isolated positions and short lengths along UGC trench.
  - v. The disposal of displaced excavated material.
  - vi. The additional cost associated with re-excavation, removal and disposal of excavated material when backfilling abandoned trial holes.

## **Particular Locations and Conditions**

### **Crossings Generally**

The excavation and reinstatement over crossings has been measured under the heading "Excavation, Backfill and Reinstatement".

The rates for crossings generally shall be deemed to include for the following: -

- i. Any delays which may be occasioned by the interruptions of the "main spread".
- ii. Any additional movement of plant, labour and materials and any other extra cost due to the nature of the crossing.
- iii. Any additional costs involved in working in a manner and at times specified for the particular Authority/owner whose property is being crossed.
- iv. Dewatering at tie-ins adjacent to the crossing.
- v. Extra costs, which may be incurred by special gangs and out of sequence work.
- vi. Any additional costs due to the nature of the adjacent terrain.
- vii. Providing continuous access at all roads and tracks.
- viii. The provision and subsequent removal of temporary stockproof fencing and gates at gaps in fences, walls and hedges abutting onto roads.

### **Open Cut Crossings**

The rates provided for open cut crossings assume that the nature of these crossings are relatively minor and for the more expansive road such as the New M3/N3 trenchless technologies will be employed.

The rates for open cut crossings shall in addition to the items given under "Crossings Generally" be deemed to include for the following: -

- i. Permanent reinstatement of traffic islands and road and footpath kerbs.



- 
- ii. Reinstatement of the road embankments where appropriate including the provision of bagged earth.
  - iii. Reinstatement of the earth banks with stone cores next roads where appropriate.
  - iv. The rate provided in the schedule assumes that the predominant road classification crossed by open cut means will be minor roads (NIRAUC Type 3 or similar). Major road crossings are assumed to be trenchless crossings.

### **Bored or Thrust Crossings**

Excavation and backfill, has been measured to the limits of the trenchless crossings as a standard trench.

Trenchless crossings shall be by pipe jack, thrustbore, micro tunnelling, horizontal directional drilling or auger boring or other such trenchless technique.

The rates for trenchless crossings shall, in addition to the items given under “Crossings Generally” and “Open Cut Crossings” where applicable be deemed to include for the following: -

- i. Provision of detailed drawings and method statements for each crossings for the approval of the Engineer and relevant authorities. Additional excavations required for the access and operation of the auger boring or jacking machine and for the reception pit.
- ii. Any necessary ground stabilisation.
- iii. The provision of foundations, deadmen, close sheeting, sheet piling and pumping as required.
- iv. Imported backfilling to thrust and reception pits with temporary and/or permanent reinstatement including saw cutting as specified.
- v. Grouting of the void between the concrete sleeve/MDPE duct and cable with appropriate grout.

### **Open Cut River, Canal and Stream Crossings**

The rates provided for open cut river and stream crossings assume that the nature of these crossings are relatively minor and for the more expansive rivers such as the River Boyne and Blackwater trenchless technologies will be employed.

The rates for open cut river, canal and stream crossings shall, in addition to the items given under “Crossings Generally” be deemed to include for the following: -

- i. Bridging or moving round of plant and equipment for access and all other protective measures to meet the requirements and conditions of appropriate Authorities, Organizations, landowners etc.

- 
- ii. Bridging and constructing temporary causeways and the like to allow for access along the working width.
  - iii. Steel piling or trench sheeting in protective works between the limits of the crossing and in addition all steel piling or trench sheeting parallel to the river or stream.
  - iv. All damming, flumes, pumps and the like and all measures required to dispose of or control the water.
  - v. Reforming on the bed and the bank to the original shape and profile and conforming to the requirements of the Authorities/owners concerned including the provision of puddle clay, rip-rap, mattresses as necessary.
  - vi. All necessary protective measures and works through embankments and approach areas to be liable to flood.
  - vii. The provision of a 150mm reinforced concrete Grade 20/30 cover slab on and including 200mm of consolidated fill or sand as directed over the top of the cables in the bed of the river, canal or stream extending the full width of the trench. Where concrete encasing is measured then this is in lieu of the concrete cover slab.
  - viii. Any other special measures in connection with the crossing shown or listed on the detailed drawing where issued prior to tendering.

## **Reinstatement**

### **Land Drain Reinstatement**

The rates for land drain reinstatement across the cable trenches shall be deemed to include for the following: -

- i. Rodding to clear the existing land drains to the edge of the working width including, where necessary, clearing obstructions outside the working width due to method of rodding drain.
- ii. Excavating and cutting back the ends of the existing land drains or box culvert drains each side of the trench and to provide purchase for the ends of the new drain and support.
- iii. Capping the exposed open end of the drain at the top of the fall.
- iv. Hand compacting and backfilling to the underside of the land drain in 150mm layers.
- v. Nailing the bitumen coated half round steel channel or heavy gauge P.V.C. channel to the oak bearers with galvanized flat head nails.
- vi. Leaving the reinstated land drains open for inspection by the land owner or occupier during the period as specified prior to backfilling.
- vii. Additional length of land drains and supports due to the width of the excavated trench being greater than the Trench Width.

---

viii. Executing by hand the initial 150mm depth of backfilling over the top of the land drain.

### **Permanent Fencing and Walling**

The rates for the erection of permanent fencing shall be deemed to include for the following: -

- i. Taking down where applicable, sufficient lengths of temporary working width fencing to allow for the erection and tying back of the permanent fence and afterwards re-erecting the temporary fencing through the permanent fence.
- ii. Straining posts and struts at changes of direction or where necessary to ensure a stable permanent fence.
- iii. Straining fence wires including the supply of patent wire strainers.
- iv. The rates for permanent stone, dry stone walling, stone and sod walling or brick walling shall be deemed to include for the following: -
  - v. Taking down stone, dry stone walling, stone and sod walling, or brick walling by hand as specified, stacking (topping stones to be stacked separately) including all haulage and afterwards re-erecting.
  - vi. Cleaning off mortar from stone or bricks prior to stacking and clear away debris.
  - vii. Stacking for re-use as specified, the material from random or coursed stonewalls.
  - viii. Supplying any additional material to make up deficiencies.
  - ix. Excavating for, and providing suitable foundations and footings.
  - x. Setting coping in mortar where necessary to match existing.
  - xi. Spanning excavations with concrete foundations including any necessary formwork, excavations or consolidation of backfill.
  - xii. Taking down, where applicable, sufficient length of temporary re-erecting the temporary fencing with additional end posts and stays.

### **Hedgerow Reinstatement**

The rates for the reinstatement of hedges and banks shall be deemed to include for the following: -

- i. Taking down where applicable, sufficient lengths of temporary working width fencing to allow for the erection and tying back of the permanent fence and afterwards re-erecting the temporary fencing through the permanent fence.
- ii. Reinstatement of hedges including re-planting with species in accordance with the requirements of the EIA and from approved 'local' sources. Such species shall be from certified 'native stock' sourced either from Ireland or Scotland.

---

## **Documentation**

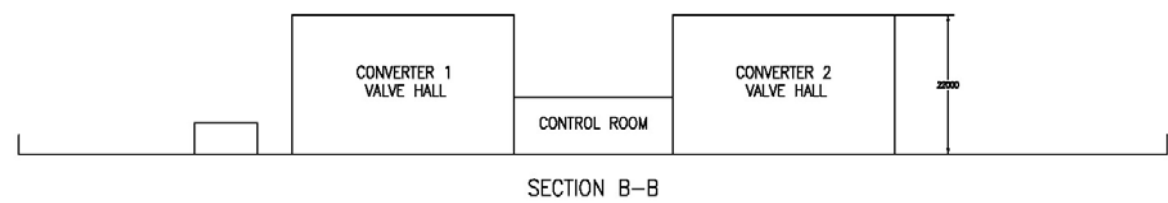
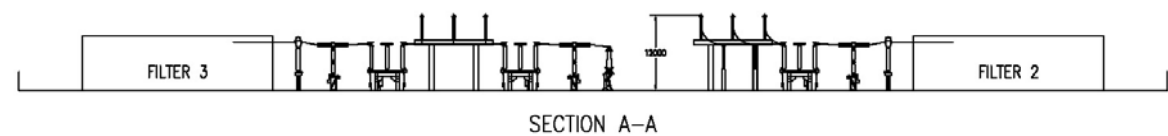
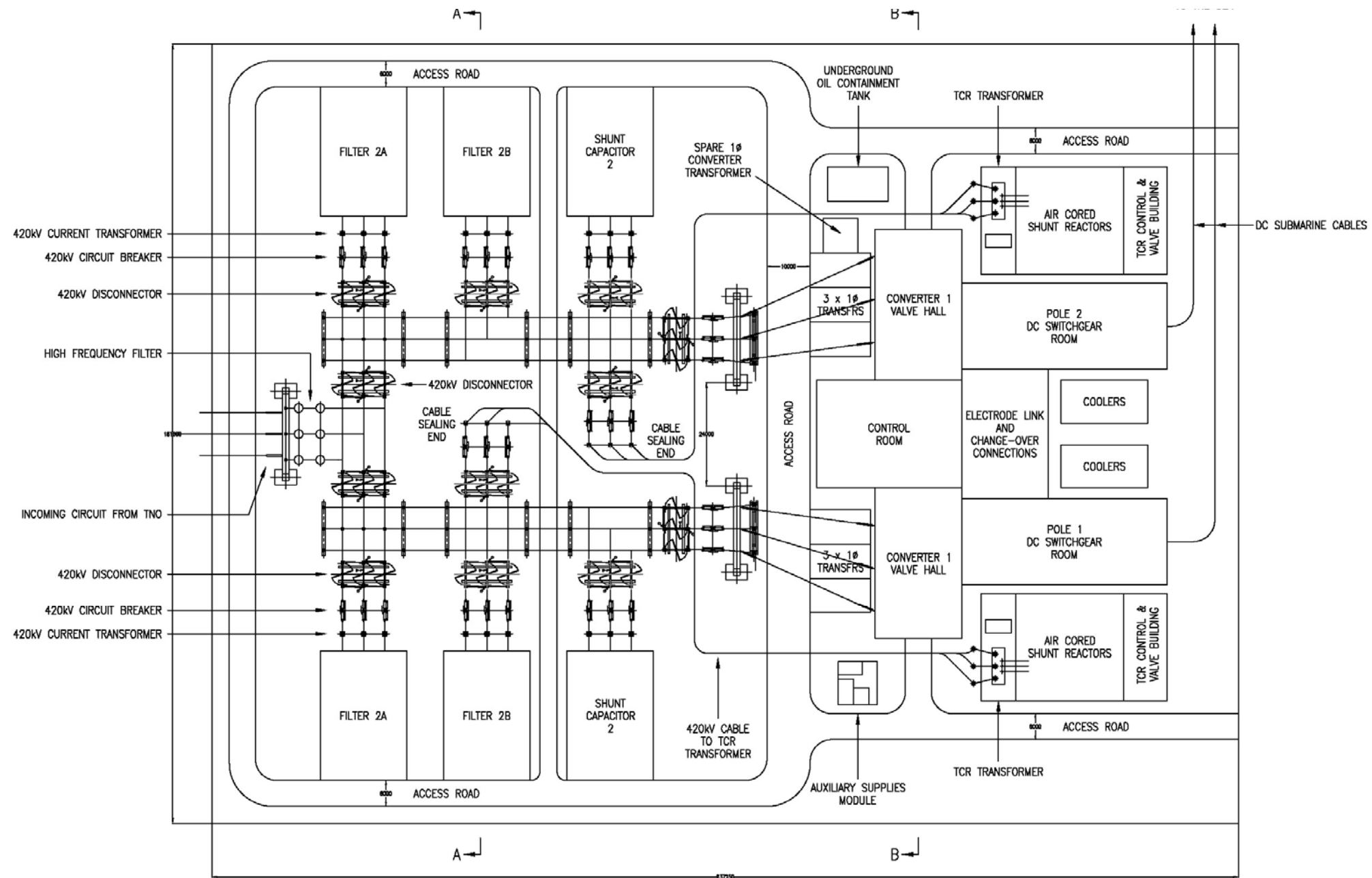
All rates are deemed inclusive of all supporting documentation/as-built records as required and defined in the scope of works and all prevailing statutory requirements.

**APPENDIX 8 - MAPS AND DRAWINGS**



## LIST OF MAPS AND DRAWINGS

Drawing No.	Title
3 IE 19038	Example HVDC converter station layout
3 IE 19035	NIE Ireland North-South Interconnector Project – Proposed Layout of 400kV Reactive Compensation Compound (2 cores per phase – segregated cores)
3 IE 19033	NIE Ireland North-South Interconnector Project – Plan of Proposed Cable Route Corridor
	Sheet 1 of 5      Map - Turleenan (Moy)
	Sheet 2 of 5      Map - Keady
	Sheet 3 of 5      Map - Northern Ireland – Republic of Ireland Border
	Sheet 4 of 5      Map - Castleblayney
	Sheet 5 of 5      Map - Kingscourt
3 IE 19034	EirGrid Meath – Cavan Connector Project – Plan of Proposed Cable Route Corridor
	Sheet 1 of 4      Map - Kingscourt
	Sheet 2 of 4      Map - River Blackwater
	Sheet 3 of 4      Map - River Boyne
	Sheet 4 of 4      Map - Woodland
3 IE 19036	NIE Ireland North-South Interconnector Project – Aerial Photograph of Proposed Cable Route Corridor
	Sheet 1 of 5      Aerial - Turleenan (Moy)
	Sheet 2 of 5      Aerial - Keady
	Sheet 3 of 5      Aerial - Northern Ireland – Republic of Ireland Border
	Sheet 4 of 5      Aerial - Castleblayney
	Sheet 5 of 5      Aerial - Kingscourt
3 IE 19037	EirGrid Meath – Cavan Connector Project – Aerial Photograph of Proposed Cable Route Corridor
	Sheet 1 of 4      Aerial - Kingscourt
	Sheet 2 of 4      Aerial - River Blackwater
	Sheet 3 of 4      Aerial - River Boyne
	Sheet 4 of 4      Aerial - Woodland



**Drawing 3-IE-19038**  
**Example HVDC converter station layout**